

**ARKANSAS STATE HIGHWAY COMMISSION
ARDOT-EQUIPMENT AND PROCUREMENT DIVISION
BID INVITATION**

Contract Number: H-20-241H

BID OPENING LOCATION:
ARDOT Equipment &
Procurement Division
11302 West Baseline Road
Little Rock, AR 72209

MAIL TO:
ARDOT Equipment &
Procurement Division
P.O. Box 2261
Little Rock, AR 72203

DELIVER TO:
ARDOT Equipment &
Procurement Division
11302 West Baseline Road
Little Rock, AR 72209

Bid Opening Date: February 6, 2020 Time: 10:00 a.m.

Sealed bids for furnishing the commodities and/or services described below, subject to the Standard Bid Conditions of this bid invitation will be received at the above-noted mail and delivery locations until the above-noted bid opening date and time, and then publicly opened at the above-noted bid opening location. **Bids must be submitted on this form, with attachments when appropriate, or bids will be rejected. Late bids and unsigned bids will not be considered. Two Signed Copies of Bid Invitation Must Be Submitted.**

In compliance with this Bid Invitation and subject to all the Conditions thereof, the undersigned offers and agrees to furnish any and all items upon which prices are quoted, at the price set opposite each item.

Company Name: _____

Name (Type or Print): _____

Address: _____

Title: _____

City: _____ State: _____ Zip: _____

Phone: _____ Fax: _____

Federal Tax ID or Social Security No.: _____

E-Mail: _____

Signature: _____

Signature must be legible, original (not photocopied) and in ink. Unsigned bids will be rejected.

REMOVAL AND DISPOSAL OF LITTER AND MOWING AND TRIMMING OF HIGHWAY RIGHT OF WAY

The Arkansas Department of Transportation (hereafter called "ARDOT") will receive sealed bids for the removal and disposal of litter and mowing and trimming of highway right of way in accordance with Special Provision for **Divided and Non-Divided** Highways, specifications and information attached to and made a part of this contract, for a period of one (1) year from date of award, to include up to three mowing cycles, with option to adjust acreage and/or renew upon mutual agreement of the parties.

All bidders should complete and return the Eligible Bidder Certification (Attachment A) and Disclosure Form (see Page 2 of Standard Bid Conditions -- Item 18) and Restriction of Boycott of Israel Certification issued with this bid. A current copy of the DFA Illegal Immigrant Contractor Disclosure Certification (see Page 1 of Standard Bid Conditions -- Item 17) should also be submitted with bid.

PROJECT LOCATION: ARDOT District 4, P.O. Box 11170, Fort Smith, AR 72917-1170 (479-484-5306)

Job No.: 4-781

Job Name: I-540

Route: Hwy. 271	Section: 1	Log Mile: 02.54 to 03.20	County: Sebastian
Route: I-540	Section: 1	Log Mile: 00.65 to 11.88	County: Sebastian
Route: I-540	Section: 2	Log Mile: 11.88 to 14.76	County: Crawford
Route: Hwy. 71	Section: 13	Log Mile: 07.40 to 10.25	County: Sebastian
Route: Hwy. 71	Section: 14	Log Mile: 00.00 to 09.83	County: Sebastian
Route: Hwy. 71	Section: 14B	Log Mile: 00.00 to 01.12	County: Sebastian

Total Acreage per Cycle = (First Cycle)	462.89
(Second Cycle)	462.89
(Third Cycle)	465.89

Bid prices shall include all costs of performing this contract, but shall exclude taxes (See Condition 5).

1. Removal and Disposal of Litter	Price per Acre \$ _____
2. Mowing and Trimming of Highway Right-of-Way	Price per Acre \$ _____
TOTAL	Total Price per Acre \$ _____

BIDS WILL BE CONSIDERED FOR COMPLETE JOB ONLY

Bid Bond in the amount of \$500.00 required of all bidders at time of bid opening or bid will be rejected. **Personal and company checks are not acceptable as Bid Bonds.** See Condition 4 on page 1 of Standard Bid Condition. **Performance Bond** in the amount of \$1000.00 will be required of successful bidder prior to providing goods/services. **Personal and company checks are not acceptable as Performance Bonds.** See Condition 4 on page 1 of Standard Bid Condition.

Person to contact in case of damage caused by contractor's operation:

<u>NAME</u>	<u>ADDRESS</u>	<u>TELEPHONE</u>
_____	_____	_____

ARDOT - STANDARD BID CONDITIONS

1. **GENERAL:** Any special terms and conditions included in the invitation for bid override these standard terms and conditions. The standard terms and conditions and any special terms and conditions become part of any contract entered into if any or all parts of the bid are accepted by the Arkansas Department of Transportation (ARDOT).
2. **ACCEPTANCE AND REJECTION:** ARDOT reserves the right to reject any or all bids, to accept bids in whole or in part (unless otherwise indicated by bidder), to waive any informalities in bids received, to accept bids on materials or equipment with variations from specifications where efficiency of operation will not be impaired, and to award bids to best serve the interest of the State.
3. **PRICES:** Unless otherwise stated in the Bid Invitation, the following will apply: (1) unit prices shall be bid, (2) prices should be stated in units of quantity specified (feet, each, lbs., etc.), (3) prices must be F.O.B. destination specified in bid, (4) prices must be firm and not subject to escalation, (5) bid must be firm for acceptance for 30 days from bid opening date. In case of errors in extension, unit prices shall govern. Discounts from bid price will not be considered in making awards.
4. **BID BONDS AND PERFORMANCE BONDS:** If required, a **Bid Bond** in the form of a cashier's check, certified check, or surety bond issued by a surety company, in an amount stated in the Bid Invitation, must accompany bid. **Personal and company checks are not acceptable as Bid Bonds.** Failure to submit a Bid Bond as required will cause a bid to be rejected. The Bid Bond will be forfeited as liquidated damages if the successful bidder fails to provide a required Performance Bond within the period stipulated by ARDOT or fails to honor their bid. When a bidder claims and can show clear and convincing evidence that a material mistake was made in the bid and was not the bid intended, the bidder may be permitted to withdraw their bid prior to award without forfeiture of bid bond. Cashier's checks and certified checks submitted as Bid Bonds will be returned to unsuccessful bidders; surety bonds will be retained. The successful bidder will be required to furnish a **Performance Bond** in an amount stated in the Bid Invitation and in the form of a cashier's check, certified check, or surety bond issued by a surety company, unless otherwise stated in the Bid Invitation, as a guarantee of delivery of goods/services in accordance with the specifications and within the time established in the bid. **Personal and company checks are not acceptable as Performance Bonds.** In some cases, a cashier's check or certified check submitted as a Bid Bond will be held as the Performance Bond of the successful bidder. Cashier's checks or certified checks submitted as Performance Bonds will be refunded shortly after payment has been made to the successful bidder for completion of all terms of the bid; surety bonds will be retained. Surety bonds must be issued by a surety company that is authorized to do business in the State of Arkansas and that is listed on the current United States Department of the Treasury Listing of Approved Sureties. Surety bonds must be executed by a resident or non-resident agent who is licensed by the Arkansas State Insurance Commissioner to represent the surety company executing the bond, and the resident or non-resident agent shall file with the bond the power of attorney of the agent to act on behalf of the bonding company. Certain bids involving labor will require Performance Bonds in the form of surety bonds only (no checks of any kind allowed). These bonds shall not only serve to guarantee the completion of the work, but also to guarantee the excellence of both workmanship and material until the work is finally accepted and the provisions of the Plans, Specifications, and Special Provisions fulfilled. In such cases, the company issuing the surety bond must comply with all stipulations herein and must be named in the U. S. Treasury listing of companies holding Certificates of Authority as acceptable sureties on Federal Bonds and as acceptable reinsuring companies. Any excess between the face amount of the bond and the underwriting limitation of the bonding company shall be protected by reinsurance provided by an acceptable reinsuring company. Annual Bid and Performance Bonds on file with E & P Division must have sufficient unencumbered funds to meet current bonding requirements, or the bid will be rejected, unless the balance is submitted as set forth above, prior to bid opening.
5. **TAXES:** The ARDOT is not exempt from Arkansas State Sales and Use Taxes, or local option city/county sales taxes, when applicable, and bidders are responsible to the State Revenue Department for such taxes. These taxes should not be included in bid prices, but where required by law, will be paid by the ARDOT as an addition thereto, and should be added to the billing to the ARDOT. The ARDOT is exempt from Federal Excise Taxes on all commodities except motor fuels; and excise taxes should not be included in bid prices except for motor fuels. Where applicable, tax exemption certificates will be furnished by the ARDOT.
6. **"ALL OR NONE" BIDS:** Bidders who wish to bid "All or None" on two or more items shall so stipulate on the face of bid sheet; otherwise, bid may be awarded on an individual item basis.
7. **SPECIFICATIONS:** Complete specifications should be attached for any substitution or alternate offered, or where amplification is necessary. Bidder's name must be placed on all attachments to the bid.
8. **EXCEPTIONS TO SPECIFICATIONS:** Any exceptions to the bid specifications must be stated in the bid. Any exceptions to manufacturer's published literature must be stated in the bid, or it will be assumed that bidder is bidding exactly as stated in the literature.
9. **BRAND NAME REFERENCES:** All brand name references in bid specifications refer to that commodity or its equivalent, unless otherwise stated in Bid Invitation. Bidder should state brand or trade name of item being bid, if such name exists.
10. **FREIGHT:** All freight charges should be included in bid price. Any change in common carrier rates authorized by the Interstate Commerce Commission will be adjusted if such change occurs after the bid opening date. Receipted common carrier bills that reflect ICC authorized rate changes must be furnished.

11. **SAMPLES, LITERATURE, DEMONSTRATIONS:** Samples and technical literature must be provided free of any charge within 14 days of ARDOT request, and free demonstrations within 30 days, unless ARDOT extends time. Failure to provide as requested within this period may cause bid to be rejected. Samples, literature and demonstrations must be substantially the same as the item(s) being bid, unless otherwise agreed to by ARDOT. Samples that are not destroyed will be returned upon request at bidders expense. Samples from successful bidders may be retained for comparison with items actually furnished.
12. **GUARANTY:** Unless otherwise indicated in Bid Invitation, it is understood and agreed that any item offered or shipped on this bid shall be newly manufactured, latest model and design, and in first class condition; and that all containers shall be new, suitable for storage or shipment and in compliance with all applicable laws relating to construction, packaging, labeling and registration.
13. **BACKORDERS OR DELAY IN DELIVERY:** Backorders or failure to deliver within the time required may constitute default. Vendor must give written notice to the ARDOT, as soon as possible, of the reason for any delay and the expected delivery date. The ARDOT has the right to extend delivery if reasons appear valid. If reason or delivery date is not acceptable, vendor is in default.
14. **DEFAULT:** All commodities furnished will be subject to inspection and acceptance by ARDOT after delivery. Default in promised delivery or failure to meet specifications authorizes the ARDOT to cancel award or any portion of same, to reasonably purchase commodities or services elsewhere and to charge full increase, if any, in cost and handling to defaulting vendor. Applicable bonds may be forfeited.
15. **ETHICS:** *"It shall be a breach of ethical standards for a person to be retained, or to retain a person, to solicit or secure a State contract upon an agreement of understanding for a commission, percentage, brokerage, or contingent fee, except for retention of bona fide employees or bona fide established commercial selling agencies maintained by the contractor for the purpose of securing business."* (Arkansas Code, Annotated, Section 19-11-708).
16. **NOTICE OF NONDISCRIMINATION:** The Arkansas State Highway Commission, through ARDOT, complies with all civil rights provisions of federal statutes and related authorities that prohibit discrimination in programs and activities receiving federal financial assistance. Therefore, ARDOT does not discriminate on the basis of race, sex, color, age, national origin, religion (not applicable as a protected group under the Federal Motor Carrier Safety Administration Title VI Program), disability, Limited English Proficiency (LEP), or low-income status in the admission, access to and treatment in the ARDOT's programs and activities, as well as the ARDOT's hiring or employment practices. Complaints of alleged discrimination and inquiries regarding the ARDOT's nondiscrimination policies may be directed to Joanna P. McFadden Section Head – EEO/DBE (ADA/504/Title VI Coordinator), P. O. Box 2261, Little Rock, AR 72203, (501)569-2298, (Voice/TTY 711), or the following email address: joanna.mcfadden@ahtd.ar.gov. Free language assistance for Limited English Proficient individuals is available upon request. This notice is available from the ADA/504/Title VI Coordinator in large print, on audiotape and in Braille.
17. **PROHIBITION OF EMPLOYMENT OF ILLEGAL IMMIGRANTS:** Pursuant to Arkansas Code Annotated 19-11-105, all bidders must certify prior to award of a contract that they **do not** employ or contract with any illegal immigrant(s) in its contract with the state. Bidders shall certify online at <https://www.ark.org/dfa/immigrant/index.php>.
18. **DISCLOSURE:** Failure to make any disclosure required by Governor's Executive Order 98-04, or any violation of any rule, regulation, or policy adopted pursuant to that order, **shall** be a material breach of the terms of this contract. Any contractor, whether an individual or entity, who fails to make the required disclosure or who violates any rule, regulation, or policy **shall** be subject to all legal remedies available to the agency.

Arkansas State Highway Commission
Contract for the Removal and Disposal of Litter
and
Mowing and Trimming of Highway Right-of-Way
BID INFORMATION

CONTRACT NO. H-20-241H

1. The Arkansas Department of Transportation (hereinafter referred to as “ARDOT”) will enter into a contract with the successful bidder (also referred to as the “Contractor”) to furnish requirements for Removal and Disposal of Litter and Mowing and Trimming of Highway Right-of-Way for the period set forth in Bid Invitation, with provision to extend annually upon mutual agreement of the parties.
2. Successful bidder must be covered by Workman’s Compensation Insurance, and Public Liability and Property Damage Insurance in the minimum amount of \$1,000,000 per occurrence and a general aggregate limit of at least \$2,000,000. Valid Certificate of Insurance **including name of insurance agent and agent’s telephone number** must be furnished to the ARDOT within 10 days of notice of award of the contract, if not already on file. Failure to provide such certification in a timely manner may result in cancellation of award and/or forfeiture of Bid Bond. Contractor will not be permitted to work until proper certification has been provided to the ARDOT. Once proper certification has been provided, Contractor is responsible to provide timely information to the ARDOT regarding any change, update, modification, renewal or cancellation of the required insurance during the contract term or any extension thereto.
3. Successful bidder is solely responsible for damages to persons and vehicles or other property (including that of the State) while fulfilling the requirements of this contract. No agency, board or commission of the State of Arkansas (including the ARDOT and the Arkansas Highway Commission) assumes any liability whatsoever for damages caused by the Contractor. All such claims must be handled by Contractor and Contractor’s insurance company. Contractor is expected to handle any claim arising from activities in fulfillment of this contract in a prompt and timely manner. Bidder shall furnish the name, address and phone number of the person (Contractor or designated employee) to be contacted in case of questions regarding damages resulting from Contractor’s operations in fulfillment of this contract.
4. Successful bidder shall notify the ARDOT immediately if unable to begin or complete work in accordance with specifications. If Contractor cannot resolve the problems and fulfill contract obligations in a manner and time frame agreeable to the ARDOT, the ARDOT shall have the option of canceling the contract effective immediately and/or deducting the cost of completion of the work from any amount due the Contractor.
5. All work under this contract is subject to inspection and acceptance by the ARDOT. Payment will be made only for work completed and accepted. No advance payment is permitted. Work completed and accepted under this contract shall be paid for at the price bid per acre (plus applicable state and local taxes, listed separately on invoice) and shall be full and complete compensation for furnishing all labor, tools, equipment and incidentals necessary to fulfill the contract requirements in a satisfactory and proper manner.
6. Invoicing may be submitted for payment no less than every two (2) weeks during each cycle for work completed and accepted. Applicable taxes must be listed separate from price per acre on invoice. Invoicing shall be submitted to the District Office listed on the Bid Invitation.
7. Failure of Contractor to comply with any provisions of this contract may result in termination of the contract, prohibition of bidding on subsequent contracts, and other remedies provided by law. This contract is expressly subject to termination by the ARDOT, for cause, upon giving the Contractor 30 days notice of intent, with reasons, to terminate.
8. Successful bidder is responsible for paying all involved employees, subcontractors, suppliers, and any applicable tax entities (State of Arkansas, city, county, etc.) in a prompt and timely manner.
9. This contract may be extended, at the original bid prices, upon the ARDOT’s giving written notice to Contractor of desire to extend and receiving the Contractor’s agreement to the extension. Expiration date of any extension shall be the anniversary date of the original award. Extension may be made on an annual basis, not to exceed the maximum number of extensions permitted by State Law.
10. The total acreage of this contract can be increased or decreased upon the ARDOT giving written notice to Contractor of desire to increase or decrease and receiving the Contractor’s agreement to this increase or decrease.

RESTRICTION OF BOYCOTT OF ISRAEL CERTIFICATION

Pursuant to Arkansas Code Annotated § 25-1-503, a public entity **shall not** enter into a contract valued at \$1,000 or greater with a company unless the contract includes a written certification that the person or company is not currently engaged in, and agrees for the duration of the contract not to engage in, a boycott of Israel.

By signing below, the Contractor agrees and certifies that they do not currently boycott Israel and will not boycott Israel during any time in which they are entering into, or while in contract, with any public entity as defined in § 25-1-503* If at any time after signing this certification the contractor decides to engage in a boycott of Israel, the contractor must notify the contracting public entity in writing.

If a company does boycott Israel, see Arkansas Code Annotated § 25-1-503.

Name of public entity	Arkansas Department of Transportation
Description of product or service	H-20-241H/ R.O.W. Mowing JOB 4-781
Contractor name	

Contractor Signature: _____ Date: _____
Signature must be hand written, in ink

“Public Entity” means the State of Arkansas, or a political subdivision of the state, including all boards, commissions, agencies, institutions, authorities, and bodies politic and corporate of the state, created by or in accordance with state law or regulations, and does include colleges, universities, a statewide public employee retirement system, and institutions in Arkansas as well as units of local and municipal government.

08102018

ATTACHMENT A

ELIGIBLE BIDDER CERTIFICATION

The Bidder represents and warrants for itself, its employees and its subcontractors and certifies they:

1. Are not presently debarred, suspended, proposed for debarment, declared ineligible, or voluntarily excluded from covered transactions by any Federal department or agency;
2. Have not within a three-year period preceding this Bid been convicted of or had a civil judgment rendered against them for commission of fraud or a criminal offense in connection with obtaining, attempting to obtain, or performing a public (Federal, State, or local) transaction or contract under a public transaction; violation of Federal or State antitrust statutes or commission of embezzlement, theft, forgery, bribery, falsification or destruction of records, making false statements, or receiving stolen property;
3. Are not presently indicted for or otherwise criminally or civilly charged by a governmental entity (Federal, State, or local) with commission of any of the offenses enumerated in paragraph two (2) of this Certification;
4. Have not within a one-year period preceding this application/Bid had one or more public transactions (Federal, State, or local) terminated for cause or default; and

The Bidder represents, warrants and acknowledges the understanding that restrictions placed on the employment of labor or on the scale of pay for the work on a contract will be the requirements of the Fair Labor Standards Act (Federal Wage-Hour Law) of 1938, 28 USC §201 et seq., and other applicable labor laws.

The person executing this Certification further represents, warrants and affirms the truthfulness and accuracy of the contents of the statements submitted on or with this Certification and understands that the provisions of 31 USC §3801 et seq. are applicable thereto.

BIDDER NAME

BY: _____

Signature

TITLE: _____

Arkansas Department of Transportation
Right-of-Way Mowing Contracts
Qualifying Your Bid

Qualifying Your Bid. If you are capable of handling the contracts on which you are bidding, and will accept award of any number from none to all on which you bid, you do not need to qualify your bid. This means that you will be awarded all contracts on which you are the low bidder, if you have sufficient equipment and provide proof of required insurance coverage. However, if you fail to honor your bid price and provide proof of insurance on all jobs on which you are the low bidder and have sufficient equipment to perform, your Bid Bond will be forfeited. If you must limit the number of contracts on which you will accept award, regardless of the number on which you submit bids, it may be to your advantage to qualify your bidding as outlined below. Doing so will allow us to award contracts according to the capabilities of bidders without forfeiture of Bid Bonds. You may qualify your bid as follows:

(1) You may bid on several contracts in hopes of being the low bidder on at least one or some, but not all. For example, you can handle only two of six jobs in which you are interested, but you want to bid on all six to increase your chances of being the low bidder on at least two. To qualify your bid in this manner, you must state the following on the Bid Invitation for every job you bid: **“Will accept award of no more than two mowing contracts.”** (You may specify any number.) This wording means you will accept award on one or two jobs (or whatever number you specified), but no more, regardless of how many on which you were the low bidder.

(2) You may bid on several contracts and indicate that a certain number must be awarded for you to accept award. For example, you can handle all five jobs in which you are interested, but you must receive award on at least two of those jobs to be able to afford your equipment. To qualify your bid in this manner, you must state the following on the Bid Invitation for every job you bid: **“Will accept award of no less than two mowing contracts.”** (You may specify any number.) This wording means you will accept award of a minimum of two jobs (or whatever number you specified) up to as many as you bid; you will receive no award if you are low bidder on less than the number you specified.

(3) You may bid a combination of (1) and (2). For example, you can handle four jobs, but must be awarded at least two, and you are going to bid several to increase your chance of being the low bidder. To qualify your bid in this manner, you must state the following on the Bid Invitation for every job you bid: **“Will accept award of no less than two nor more than four mowing contracts.”** (You may specify any numbers.) This wording means that you will accept award on a minimum of two and a maximum of four jobs (or whatever numbers you specified), regardless of how many on which you were the low bidder.

(4) You may qualify your bids in such a way that you will accept award only if all the contracts on which you bid are awarded to you. (See Page 1 of Standard Bid Conditions.) To qualify your bid in this manner, you must write **“All or None”** on the Bid Invitation for every job you bid. This means that you will accept award of no less than all of the contracts on which you submitted bids; if all of your bids are not awarded to you by ARDOT, you will receive no award, even if you are the lowest bidder on some.

ILLEGAL IMMIGRANT CERTIFICATION

Pursuant to Arkansas Code Annotated § 19-11-105, Contractor(s) **shall** certify with OSP that they do not employ or contract with illegal immigrants.

By signing below, the Contractor agrees and certifies that they do not employ illegal immigrants and will not employ illegal immigrants during the remaining aggregate term of the contract.

Bid Number/Contract Number	H-20-241H
AASIS Number	N/A
Description	R.O.W. Mowing JOB 4-781
Contractor name	

Contractor Signature: _____
Signature must be hand written, in ink

Date: _____

CONTRACT AND GRANT DISCLOSURE AND CERTIFICATION FORM

Failure to complete all of the following information may result in a delay in obtaining a contract, lease, purchase agreement, or grant award with any Arkansas State Agency.

SUBCONTRACTOR: _____

Yes No

IS THIS FOR:

Goods? Services? Both?

TAXPAYER ID NAME: _____

YOUR LAST NAME: _____

FIRST NAME: _____

M.I.: _____

ADDRESS: _____

CITY: _____

STATE: _____

ZIP CODE: _____

COUNTY: _____

AS A CONDITION OF OBTAINING, EXTENDING, AMENDING, OR RENEWING A CONTRACT, LEASE, PURCHASE AGREEMENT, OR GRANT AWARD WITH ANY ARKANSAS STATE AGENCY, THE FOLLOWING INFORMATION MUST BE DISCLOSED:

FOR INDIVIDUALS*

Indicate below if: you, your spouse or the brother, sister, parent, or child of you or your spouse is a current or former: member of the General Assembly, Constitutional Officer, State Board or Commission Member, or State Employee:

Position Held	Mark (<input checked="" type="checkbox"/>)		Name of Position of Job Held <small>(senator, representative, name of board/ commission, data entry, etc.)</small>	For How Long?		What is the person(s) name and how are they related to you? <small>(i.e., Jane Q. Public, spouse, John Q. Public, Jr., child, etc.)</small>	Relation
	Current	Former		From MM/YY	To MM/YY		
General Assembly							
Constitutional Officer							
State Board or Commission Member							
State Employee							

None of the above applies

FOR AN ENTITY (BUSINESS)*

Indicate below if any of the following persons, current or former, hold any position of control or hold any ownership interest of 10% or greater in the entity: member of the General Assembly, Constitutional Officer, State Board or Commission Member, State Employee, or the spouse, brother, sister, parent, or child of a member of the General Assembly, Constitutional Officer, State Board or Commission Member, or State Employee. Position of control means the power to direct the purchasing policies or influence the management of the entity.

Position Held	Mark (<input checked="" type="checkbox"/>)		Name of Position of Job Held <small>(senator, representative, name of board/ commission, data entry, etc.)</small>	For How Long?		What is the person(s) name and what is his/her % of ownership interest and/or what is his/her position of control?	Ownership Interest (%)	Position of Control
	Current	Former		From MM/YY	To MM/YY			
General Assembly								
Constitutional Officer								
State Board or Commission Member								
State Employee								

None of the above applies

Contract and Grant Disclosure and Certification Form

Failure to make any disclosure required by Governor's Executive Order 98-04, or any violation of any rule, regulation, or policy adopted pursuant to that Order, shall be a material breach of the terms of this contract. Any contractor, whether an individual or entity, who fails to make the required disclosure or who violates any rule, regulation, or policy shall be subject to all legal remedies available to the agency.

As an additional condition of obtaining, extending, amending, or renewing a contract with a state agency I agree as follows:

1. Prior to entering into any agreement with any subcontractor, prior or subsequent to the contract date, I will require the subcontractor to complete a **CONTRACT AND GRANT DISCLOSURE AND CERTIFICATION FORM**. Subcontractor shall mean any person or entity with whom I enter an agreement whereby I assign or otherwise delegate to the person or entity, for consideration, all, or any part, of the performance required of me under the terms of my contract with the state agency.
2. I will include the following language as a part of any agreement with a subcontractor:

Failure to make any disclosure required by Governor's Executive Order 98-04, or any violation of any rule, regulation, or policy adopted pursuant to that Order, shall be a material breach of the terms of this subcontract. The party who fails to make the required disclosure or who violates any rule, regulation, or policy shall be subject to all legal remedies available to the contractor.
3. No later than ten (10) days after entering into any agreement with a subcontractor, whether prior or subsequent to the contract date, I will mail a copy of the **CONTRACT AND GRANT DISCLOSURE AND CERTIFICATION FORM** completed by the subcontractor and a statement containing the dollar amount of the subcontract to the state agency.

Signature _____	Title _____	Date _____
Vendor Contact Person _____	Title _____	Phone No. _____

Agency Use Only			
Agency Number _____	Agency Name _____	Agency Contact Person _____	Contact Phone No. _____
			Contract or Grant No. _____

THE GOOD NEIGHBOR POLICY

The "good neighbor policy" is the practice of matching the highway right-of-way vegetation height to that of the adjacent privately owned land. Where the frontage of properties are cleared and maintained by cultivating, mowing, grazing or haying and lie directly adjacent to the right-of-way, the right-of-way is to be mowed full width on the final mowing cycle. Some areas may require mowing on each cycle i.e. residences and businesses. For wooded or brushy property or where agreed to by the property owner, this policy is not necessary.

Additionally, property owners whose property abuts the right of way on non-controlled access roads are allowed to mow and maintain their frontage under certain circumstances. Refer to Ark. Code Ann. §27-64-103. This is extended to allow minor clearing that generally does not denude the right of way of vegetation. Major clearing that could affect public safety, cause drainage, or erosion problems may require a Department permit. Denuding areas greater than one acre also requires an NPDES permit.

On controlled access freeways, the right-of-way is maintained at standard mowing widths or established mowing widths regardless of the adjacent property. If an adjoining property owner requests additional mowing and/or clearing, the Department will review the request. The review would include District, Environmental and Administrative personnel. If approved, the permit would typically allow the property owner to do selective clearing and/or mowing and be accomplished and maintained by the owner at no expense to the Department.

ARKANSAS DEPARTMENT OF TRANSPORTATION
SPECIAL PROVISION
REMOVAL AND DISPOSAL OF LITTER
AND
MOWING AND TRIMMING OF HIGHWAY RIGHT-OF-WAY
FOR DIVIDED HIGHWAYS

Central Mowing Zone

DESCRIPTION: This work shall consist of removal and disposal of litter and the mowing and trimming of the highway rights of way for vegetation control. The Contractor shall provide all labor, equipment, and materials to accomplish the removal and disposal of litter and the mowing and trimming for one growing season of the designated areas in accordance with these specifications, plans and as directed by the Engineer. The Engineer is the District Engineer or their authorized representative. A mowing cycle shall be removal and disposal of litter and one complete mowing of the areas designated on the Plans.

PROJECT SCOPE: The route(s) along which work is to be performed will be designated in the contract and the project limits defined by the beginning and ending log miles. Within the limits of this project, the following areas adjacent to the main lanes and ramps shall be mowed and trimmed.

1. A normal mowing swath thirty (30) feet wide extending outward from the outside edge of the outside paved shoulder.
2. A normal mowing swath thirty (30) feet wide extending into the median from the inside edge of the inside paved shoulder. Median areas less than (90) feet in width and other areas designated on the plans shall be mowed in entirety.
3. Trimming around all fixed objects, including but not limited to guardrails, delineators, signs, culvert headwalls, bridge abutments and bridge piers, is required and shall be performed concurrently with the mowing operation.
4. The mowing of interchanges shall consist of a thirty (30) foot swath along both sides of the ramps and the crossroads between ramp intersections.
5. If transition zones in the interchanges are included in the mowing quantities, they shall be mowed as part of the 3rd mowing cycle in accordance with the plan quantities and the attached drawings.

Mowing widths will vary as necessary to accommodate the good neighbor policy, drainage etc. **All drainage areas will be mowed on the second cycle unless indicated, otherwise on the contract quantity sheets.** The mowing acreage for these areas will be reflected in the mowing widths shown on the plans.

Exceptions, which are not to be mowed, may be designated by the Engineer to accommodate construction projects, wildflower blooms, lack of growth, etc. The acreage for not mowing these areas shall be deducted from the totals for payment. Additionally, the Engineer may reduce the total number of mowing cycles if growing conditions render a mowing unnecessary. If areas are designated to not be mowed or the number of cycles is reduced, removal and disposal of litter may be performed in those areas as determined by the Engineer.

ARKANSAS DEPARTMENT OF TRANSPORTATION
SPECIAL PROVISION
REMOVAL AND DISPOSAL OF LITTER
AND
MOWING AND TRIMMING OF HIGHWAY RIGHT-OF-WAY
FOR DIVIDED HIGHWAYS

Central Mowing Zone

EQUIPMENT: The equipment to be used on this contract shall be in good working condition and suitable for safe mowing the rights-of-way of the highway and for performing the work required under this contract. Any equipment determined by the Engineer to be a hazard to highway users or unsuitable for operation on the highway right-of-way shall not be used in the work. Sufficient equipment and accessory items for efficient operation and completion of the cycle in the designated time shall be provided. All rotary-type mowers shall be equipped with skirt guards to restrict foreign objects from being thrown out of the cutting unit enclosures. Tractors shall be equipped to conform to prevailing Federal and State health and safety regulations and standards, including flashing amber lights and slow moving equipment emblems.

The use of batwing mowers shall be limited to areas of sufficient width to allow the operation of all sections of the mowers in the down position at all times. Where the width is restricted or narrow because of the location of signs or other obstructions, the use of batwing mowers is prohibited. Mowers shall not be operated with a portion of the mower deck extended into the driving lane. When a mower of any type is being moved from one site to another under its own power with the mower unit raised, the PTO shaft for the mower unit shall be disengaged.

All vehicles used on the project for bagged litter pickup will be equipped with at least one 6-inch diameter flashing amber light, visible in all directions. Any litter not bagged or subject to being blown from the vehicle shall be covered.

REMOVAL AND DISPOSAL OF LITTER: Prior to each mowing cycle, the areas to be mowed shall be cleaned of litter and hazardous objects that might be thrown by the mowers. For the purpose of this contract, litter is defined as trash, garbage, debris and refuse of the following type: Paper, plastic, bottles, cans, wood, tires, tire parts, metal products, etc. In addition, all litter, which is revealed by the mowing operation, shall be picked up within 48 hours. **Any litter placed in bags before or after mowing shall be removed from the right of way within 24 hours of bagging. Failure to remove litter in a timely manner, as stated above, will result in liquidated damages of \$250 per day.**

All litter disposals shall be according to all local, State and Federal regulations in a permitted landfill or permitted disposal facility.

MOWING PROCEDURES: Representatives of the Department and the Contractor shall meet prior to beginning of the first mowing cycle and prior to others if necessary to review the work to be done. After the meeting, the Contractor's primary contact in all matters relating to the work will be the Area Maintenance Supervisor in each maintenance area. The Area Supervisor's telephone number will be provided. Failure to maintain contact with each district representative may be used as grounds for not renewing the contract the following mowing season.

ARKANSAS DEPARTMENT OF TRANSPORTATION
SPECIAL PROVISION
REMOVAL AND DISPOSAL OF LITTER
AND
MOWING AND TRIMMING OF HIGHWAY RIGHT-OF-WAY
FOR DIVIDED HIGHWAYS

Central Mowing Zone

The Contractor shall perform three scheduled mowing cycles, each to be completed as noted below:

1st Mowing: Between April 15 and May 24

2nd Mowing: Between July 1 and August 9

3rd Mowing: Between October 1 and the day before Thanksgiving Day (inclusive of those days)

Each contract stands alone and is to be completed prior to the specified completion date. The Contractor shall begin work on the first cycle within ten (10) working days of issuance of a work order. The Contractor shall not begin subsequent mowing cycles until receiving approval from the Engineer or his designee. Each mowing cycle shall be completed within fourteen (14) working days of commencement of work, in a continuous operation, and shall be completed within the time period specified. All contracts will be mowed in the same sequence as the first mowing. A mowing cycle is considered complete when all mowing, hand trimming and litter removal are complete to the satisfaction of the Engineer.

Time is of the essence in this Contract and it is important that the work be pressed vigorously to completion. Loss will accrue to the public due to delayed completion of the mowing cycles. Where the mowing is not completed and accepted by the times specified for each mowing cycle, the sum of \$250 per day will be deducted from any money due the Contractor, not as a penalty, but as liquidated damages.

LIQUIDATED DAMAGES – RAIN DAYS: Rain days are allowed as an extension to the completion date for any day that the contractor, because of excessive rain, was not able to employ 60% of his forces for 60% of the day, or on days he was instructed by the Department not to mow because of wet conditions.

Should a Contractor have more than one mowing contract, rain days that interrupt his progress on the job he is actually working on will not be counted toward the extension of time on his other contracts during that mowing cycle.

The Contractor must contact the Area Maintenance Supervisor for determination of rain day status. Any appeal of time charges shall be made to the District Engineer in writing, within 30 days of submitting the invoice for payment.

Before submitting an invoice and before moving mowers off the project or to the next route, the Contractor shall inspect the work for compliance, and then contact the Area Supervisor for a final inspection. The contract day count will end when the contractor contacts the Area Maintenance Supervisor for final inspection. If remedial work is required, the day count will continue until all work is

ARKANSAS DEPARTMENT OF TRANSPORTATION
SPECIAL PROVISION
REMOVAL AND DISPOSAL OF LITTER
AND
MOWING AND TRIMMING OF HIGHWAY RIGHT-OF-WAY
FOR DIVIDED HIGHWAYS

Central Mowing Zone

completed. If this inspection is not performed within two working days, the Contractor is relieved of performing any remedial work. Failure to contact the Area Maintenance Supervisor can be used as grounds for not renewing the contract the following mowing season.

GENERAL REQUIREMENTS: Mowing shall be performed only during daylight hours. Failure to conform to this is considered a major safety violation and the contractor will be penalized one day of Liquidated Damages. A second major safety violation will result in suspension of the work.

Extreme caution and appropriate safety measures shall be taken when it is necessary for the equipment to cross the main traffic lanes. An escort shall be provided when equipment crosses the main lanes. Mowers shall cross any bridge in the same direction as traffic. Failure to follow these requirements shall be considered a major safety violation and the contractor will be penalized one day of Liquidated Damages. A second major safety violation will result in suspension of the work.

For all areas designated to be mowed, the mowed vegetation shall be uniform and 4 to 6 inches in height. The Contractor shall mow only those areas that are designated. The Contractor shall mow as close as practicable to all fixed objects and hand trim vegetation around all fixed objects to a 4 to 6 inch height. Trimming shall be performed concurrently with and consistent with the pace of the mowing operation.

The Contractor shall conduct his operations in such a manner that he does not damage the existing ground areas, trees, shrubs, guardrail, signs, utilities, delineators or other structures. The Contractor shall not mow during wet conditions where turf damage or rut damage would occur. In the event damage occurs to Department property as a result of mowing operations, the Contractor shall replace or repair the damaged areas or items at no cost to the State as directed by the Engineer. Failure to perform any remedial work as a result of the contractor's operations within 30 days of written notification will result in the contractor being placed in default

On days that a Contractor cannot mow a minimum of 6 hours because of rain or wet ground conditions, that day may be considered a rain day and will extend the overall time permitted to complete the mowing contract. The Contractor must contact the Area Supervisor for rain day status. The Contractor will be allowed to perform litter removal and trimming operations on rain days as long as the workers present are operating within the limits of advanced warning signs.

The operator shall straighten delineators and signs that are bent over during mowing at the time that they are damaged. Any cuttings that could restrict drainage flow shall be removed from culvert inlets at the time they are obstructed. If damaged property resulting from the Contractor's operations requires repair or replacement by the Department, the cost of such work shall be deducted from monies due the Contractor. Mowing with rotary mowers shall be in such a manner that cuttings and debris are ejected away from the roadway (See attached drawing). If debris is thrown or carried onto the paved surface by mowing or trimming operations, the Contractor shall immediately remove the debris. If the Contractor

ARKANSAS DEPARTMENT OF TRANSPORTATION
SPECIAL PROVISION
REMOVAL AND DISPOSAL OF LITTER
AND
MOWING AND TRIMMING OF HIGHWAY RIGHT-OF-WAY
FOR DIVIDED HIGHWAYS

Central Mowing Zone

fails to immediately remove debris, the Engineer may have the debris removed by Department forces and deduct the cost of the work from monies due the Contractor.

When equipment is not in use, it shall be parked or stored off the pavement or shoulder of the highway in an inconspicuous location no less than 30 feet from the edge of pavement or as directed by the Engineer. Under no circumstances shall mowers be parked or stored in median areas less than 100 feet in width.

Since worker safety and safety of the traveling public is a Department priority, repeated offenses of unsafe ingress and egress of the traveled lanes and parking closer than 30 feet from the edge of the traveled lane may considered a major safety violation and the contractor will be penalized one day of Liquidated Damages. A second major safety violation will result in suspension of the work.

Should a Contractor choose to sublet part of the work to another Contractor, approval in writing is required by the Department. The Contractor subletting the work must perform a minimum of 40% of the work specified in the contract. The Contractor performing the work must have the required proof of liability insurance and workman's compensation on file with the department. This does not alter the completion date on the contract.

ADVANCE WARNING SIGNS: The Contractor shall furnish portable signs in accordance with the Manual on Uniform Traffic Control Devices to notify the traveling public of mowing, trimming and litter removal operations. The Contractor shall place these signs along the highway during any operation involving litter removal, mowing, or trimming and shall remove them immediately after the operation ceases.

The signs used shall be diamond shaped with black letters on an orange, reflective background with a black border.

Whenever mowers are operating, or trimming work is being done, the signs shall be a minimum size of 36" x 36", and the words on the signs shall be MOWERS WORKING AHEAD (W21-8) with a minimum letter size of five (5) inches.

When litter removal only is being done the signs used shall be a minimum size of 36" x 36", and the words on the signs shall be ROAD WORK AHEAD (W20-1) with a minimum letter size of five (5) inches.

These signs shall be mounted on the shoulder at the beginning points of the operation for both directions of travel. Signs shall be mounted so that the bottom of the sign is not less than one (1) foot above the pavement edge. Higher mounting heights are desirable. The contractor's signs shall not be mounted to existing Department sign assemblies or supports. Each sign shall be mounted on an individual sign

ARKANSAS DEPARTMENT OF TRANSPORTATION
SPECIAL PROVISION
REMOVAL AND DISPOSAL OF LITTER
AND
MOWING AND TRIMMING OF HIGHWAY RIGHT-OF-WAY
FOR DIVIDED HIGHWAYS

Central Mowing Zone

support. Litter removal, mowing, and trimming operations shall not extend more than five (5) miles beyond the advance warning signs. As operations advance, the warning signs shall be advanced so as to maintain the operations within five (5) miles of the advance warning signs. Additional signs may be used to extend operations.

Failure to follow these requirements are considered a safety violation and the contractor's work be suspended for the remainder of the day and the day will be counted as a work day.

Advance warning signs will not be measured or paid for separately, but will be considered included in the unit prices bid per acre for Removal and Disposal of Litter and for Mowing and Trimming.

SAFETY APPAREL FOR WORKERS: All workers shall be provided with high visibility safety apparel meeting the Performance Class 2 or 3 requirements of ANSI/ISEA 107-2004, "American National Standard for High-Visibility Safety Apparel and Headwear", in accordance with regulations for workers on Federal Aid Highways. Failure to wear the safety apparel while working on the right of way is considered a major safety violation and the contractor will be penalized one day of Liquidated Damages. A second major safety violation will result in suspension of the work.

CONTRACTOR LIABILITY: The Contractor must assume full liability (not just the deductible) for hazards to traffic that might be created by the mowing operation and save harmless the Arkansas Highway Commission and the Arkansas Department of Transportation in all respects.

The Contractor shall procure and maintain at its sole cost and expense, for the life of the Contract, Workman's Compensation Insurance and General Public Liability Insurance providing bodily injury, including death, personal injury, and property damage coverage with a minimum limit of at least \$1,000,000 per occurrence and a general aggregate limit of at least \$2,000,000. Valid certificate of insurance including name of insurance agent and agent's phone number must be furnished to the Department's Procurement office within 10 days of notice of award of the contract if not already on file. Failure to provide such certification in a timely manner will result in cancellation of award and/or forfeiture of bid bond. The contractor will not be permitted to work until proper certification has been provided to the Department. Each policy or its declaration pages shall provide that the policy shall not be materially changed or canceled until the Department has been given at least 30 days advance notice in writing. If any policy is canceled during the duration of the work, a satisfactory replacement policy shall be in force, with notice and evidence of insurance to the Department, prior to the effective date of cancellation of the former policy.

ARKANSAS DEPARTMENT OF TRANSPORTATION
SPECIAL PROVISION
REMOVAL AND DISPOSAL OF LITTER
AND
MOWING AND TRIMMING OF HIGHWAY RIGHT-OF-WAY
FOR DIVIDED HIGHWAYS

Central Mowing Zone

Additionally, failure to furnish written notice, 30 days in advance, of cancellation or change in the policy, during any mowing cycle, will result in the termination of the Contract and the Contractor will be placed in default status.

The Contractor must furnish the Engineer the name, address and phone number of the person to be contacted in case of damage to vehicles or other property caused by the Contractor's operations. This information and the Contractor's insurance agent may be provided to claimants who contact the Department with an alleged claim.

QUALIFICATION PROVISION FOR AWARD: Contractors who are apparent low bidders will be notified and will be required to submit a list of available or planned mowing equipment to assure that adequate resources are available to complete the contract in the allotted time. Equipment resources will be evaluated by the Department prior to award based on the following performance:

6' Bush hog	45-55 HP	12 Acres/Day
15' Bush hog	55-75 HP	24 Acres/Day

Contract award will be based on the capacity of the contractor to perform the work within the specified contract time. **The Department will not award additional contract(s) to any bidder who has not completed all current jobs within the specified period allotted for each cycle or is in liquidated damages on any mowing project. Any contractor who has not started mowing at least by the completion date on a contract will be placed in default status. Rain days will be considered in the determination of completion date and liquidated damages.** Projects not awarded will go to the next lowest bidder.

DEFAULT AND TERMINATION OF CONTRACT: The Engineer may give written notice of delay, neglect, or default to both the Contractor and the Surety if the Contractor:

 Fails to perform work according to these specifications, or

 Fails to begin work within the time specified, or

 Fails to perform the work with sufficient resources to assure timely completion, or

 Fails to perform the work in accordance with the contract requirements or neglects or refuses to correct rejected or unacceptable work, or

ARKANSAS DEPARTMENT OF TRANSPORTATION
SPECIAL PROVISION
REMOVAL AND DISPOSAL OF LITTER
AND
MOWING AND TRIMMING OF HIGHWAY RIGHT-OF-WAY
FOR DIVIDED HIGHWAYS

Central Mowing Zone

Discontinues the prosecution of the work without authority, and/or fails to resume work that has been discontinued within a reasonable time after notice to do so, or

If at any time the sum of liquidated damages exceeds the total contract price, the contractor shall be deemed in default and the rights of the contractor to perform the contract terminated. It is agreed that said liquidated sum is not a penalty and shall be used for reimbursement to the Department for extended inspection and contract administration.

For any other cause whatsoever does not carry on the work in an acceptable manner.

If a Contractor is defaulted or quits a contract, or has a principal who is also principal of any firm, partnership, or corporation which has defaulted on another Contract, the Contractor, principal or persons previously working with said principal or Contractor will not be allowed to bid on another Department mowing project for a period of twelve months.

METHOD OF MEASUREMENT: Quantities for Mowing and Trimming and Removal and Disposal of Litter, as shown on the Plans and in the Proposal shall be considered as final quantities and no further measurements will be made unless modified by the Engineer, as described above, or upon evidence furnished by the Contractor, substantial variations exist between quantities shown on the plans and actual quantities. Each mowing cycle will be measured separately.

Removal and Disposal of Litter quantities will be the same quantities on the Plans and in the Proposal designated for Mowing and Trimming. Removal and Disposal of Litter shall include the removal of litter before each mowing cycle (and after as necessary) within the designated mowing areas and the approved disposal of the litter. Quantities for Removal and Disposal of Litter will be measured separately for each mowing cycle.

ARKANSAS DEPARTMENT OF TRANSPORTATION
SPECIAL PROVISION
REMOVAL AND DISPOSAL OF LITTER
AND
MOWING AND TRIMMING OF HIGHWAY RIGHT-OF-WAY
FOR DIVIDED HIGHWAYS

Central Mowing Zone

BASIS OF PAYMENT: Work completed and accepted under this item and measured as provided above will be paid for at the contract unit price bid per acre for Mowing and Trimming and for Removal and Disposal of Litter which shall be full compensation for mobilization, furnishing all labor, equipment, tools, materials, and incidentals necessary to complete the work. Partial payments shall be made at two-week intervals for work performed and accepted during the preceding two weeks.

Payment will be made under:

ITEM	PAY UNIT
Removal and Disposal of Litter	Acre
Mowing and Trimming	Acre

MWSPNDIV_00.DOC

1/9/17

ARKANSAS DEPARTMENT OF TRANSPORTATION
SPECIAL PROVISION
REMOVAL AND DISPOSAL OF LITTER
AND
MOWING AND TRIMMING OF HIGHWAY RIGHT-OF-WAY
FOR DIVIDED HIGHWAYS

Central Mowing Zone

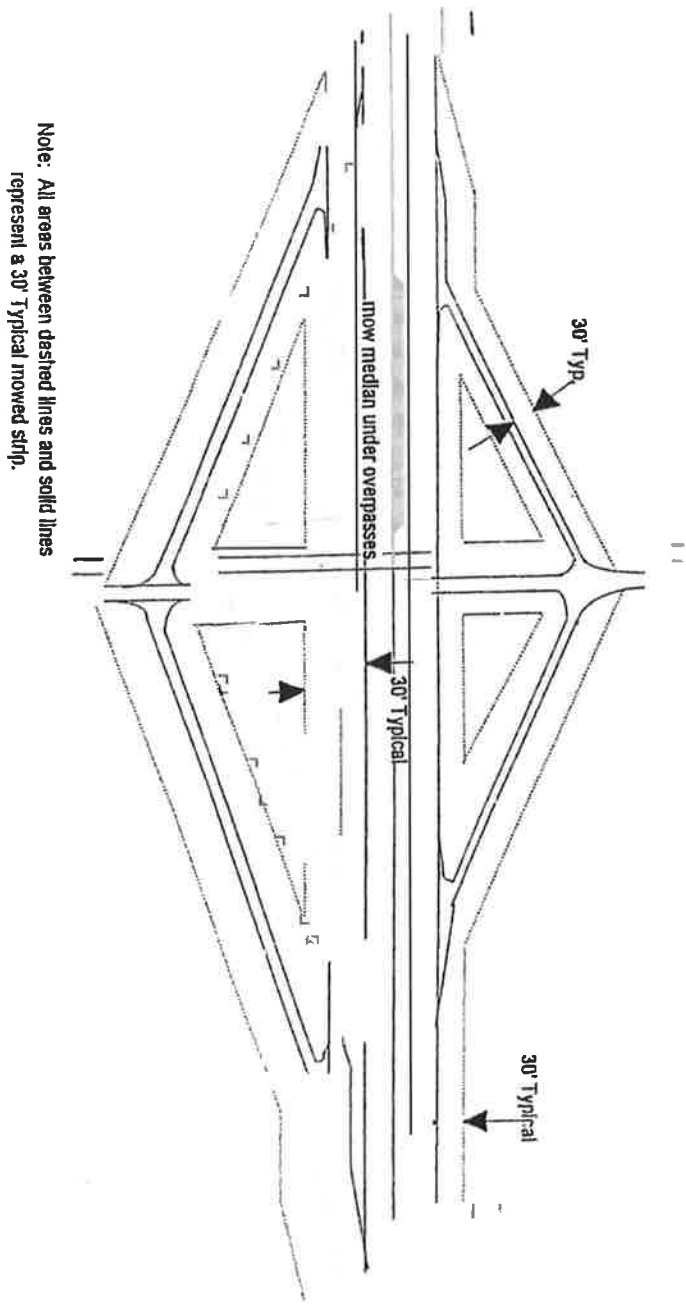

Note: All areas between dashed lines and solid lines represent a 30' Typical mowed strip.

TYPICAL INTERCHANGE MOWING



ARKANSAS DEPARTMENT OF TRANSPORTATION
SPECIAL PROVISION
REMOVAL AND DISPOSAL OF LITTER
AND
MOWING AND TRIMMING OF HIGHWAY RIGHT-OF-WAY
FOR DIVIDED HIGHWAYS

Central Mowing Zone

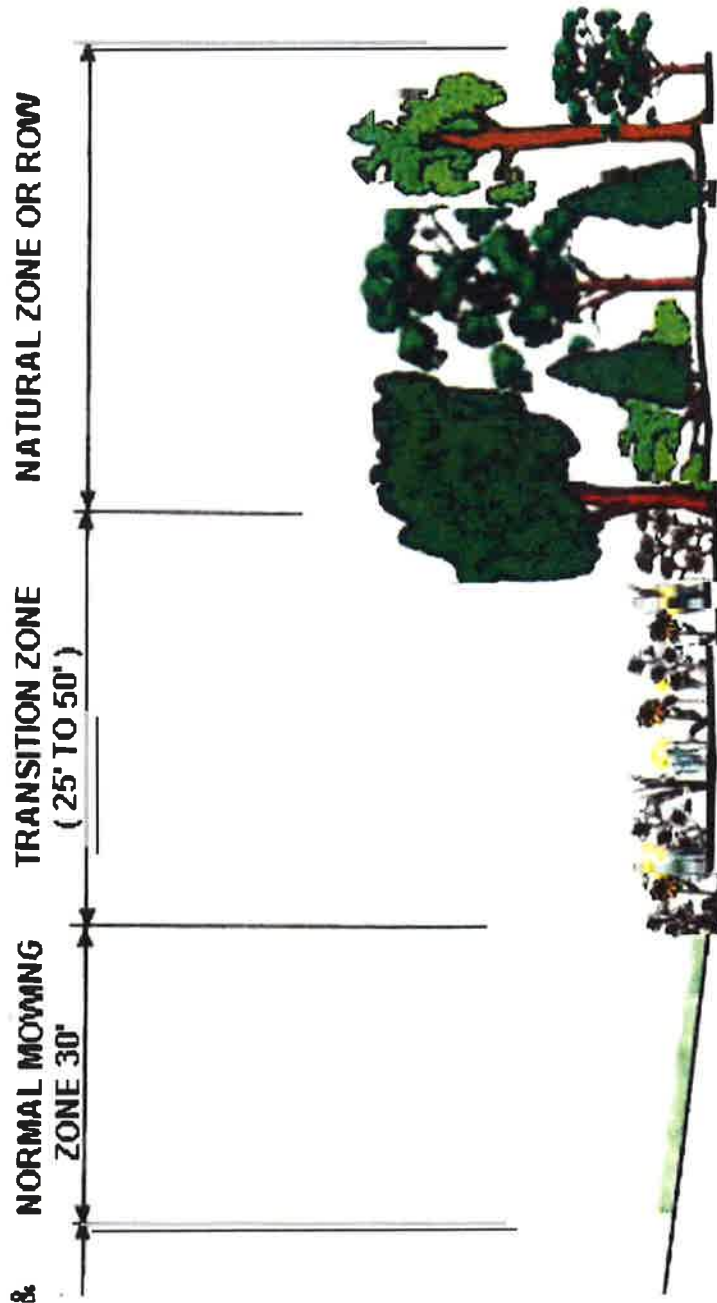

TRANSITION MOWING # 1

ARKANSAS DEPARTMENT OF TRANSPORTATION

SPECIAL PROVISION

REMOVAL AND DISPOSAL OF LITTER
AND
MOWING AND TRIMMING OF HIGHWAY RIGHT-OF-WAY
FOR DIVIDED HIGHWAYS

Central Mowing Zone

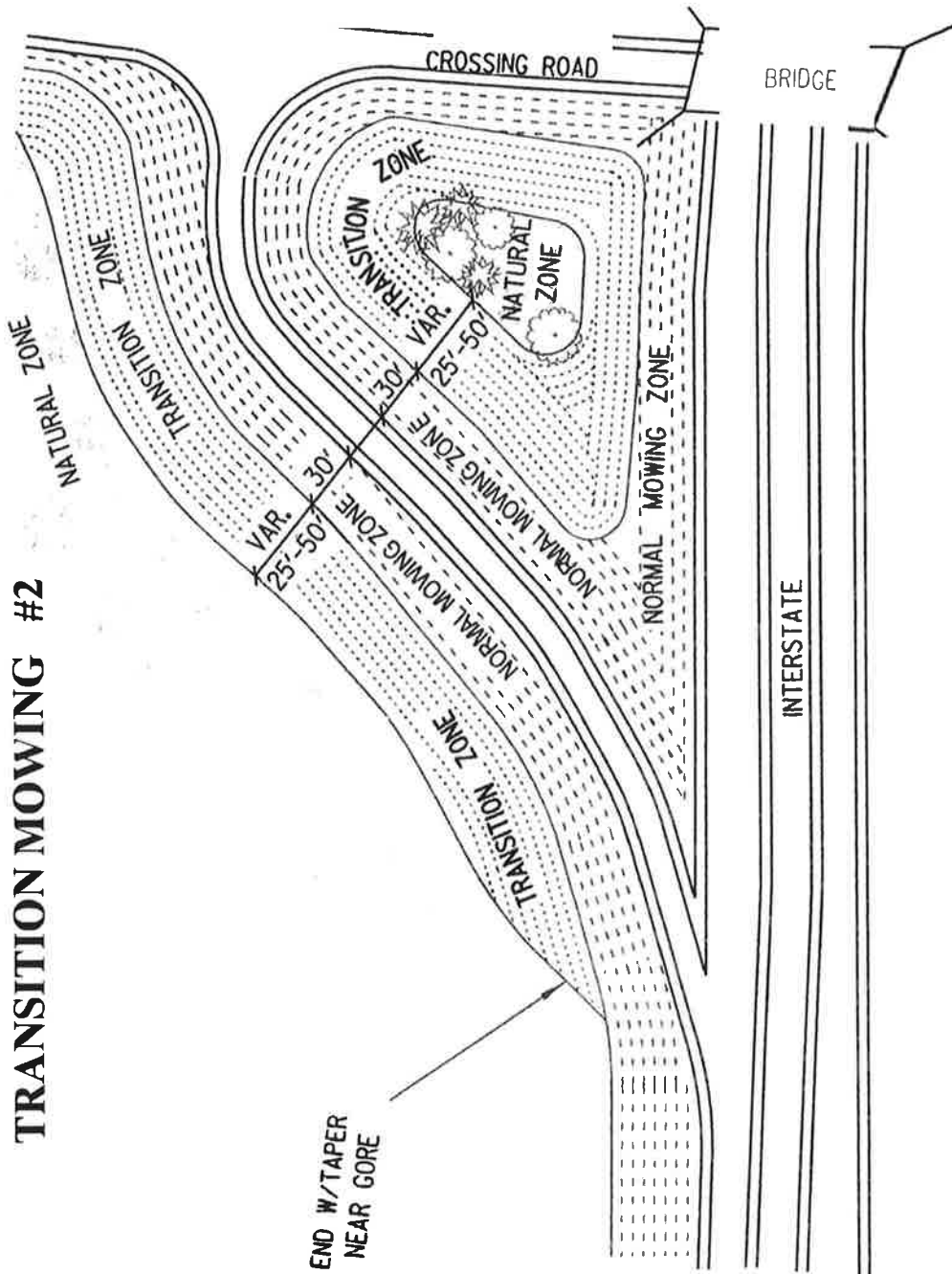

ARKANSAS DEPARTMENT OF TRANSPORTATION
SPECIAL PROVISION
REMOVAL AND DISPOSAL OF LITTER
AND
MOWING AND TRIMMING OF HIGHWAY RIGHT-OF-WAY
FOR DIVIDED HIGHWAYS

Central Mowing Zone

TRANSITION MOWING #3

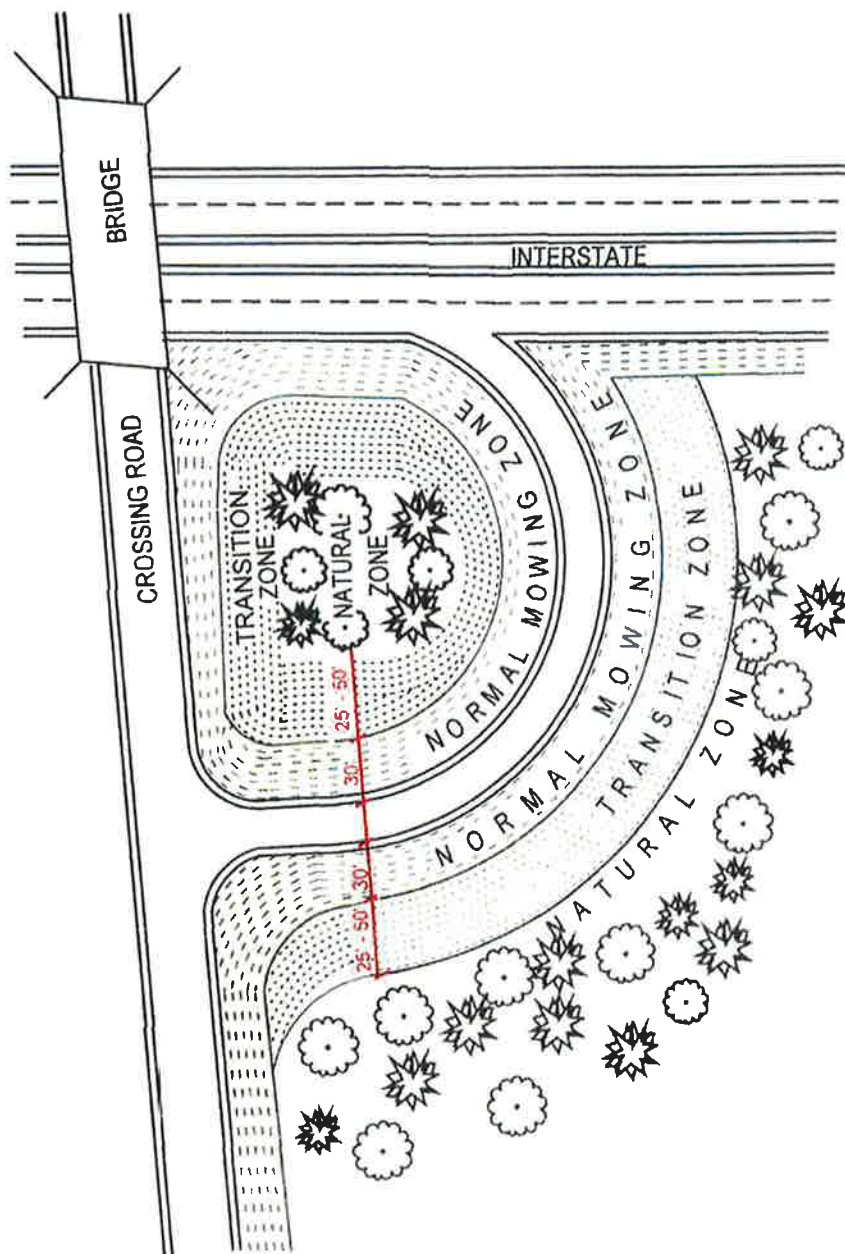

ARKANSAS STATE HIGHWAY AND TRANSPORTATION DEPARTMENT
 SUPPLY CONTRACT FOR MOWING AND TRIMMING OF HIGHWAY RIGHT OF WAY
 QUANTITIES FORM FOR ONE(1) MOWING CYCLE

Job No.:
 Route: I-540/Hwy 271
 Job Limits: L.M. 0.00/2.54 to L.M. 14.76/3.20
 Counties Crawford and Sebastian

Bidder: _____

Area Limits	Log Mile to Log Mile:	Length (Feet)	Width(Ft.) & Limit of Mowing								Acres	
			Left Main Lanes				Right Main Lanes					
			Limit	Width	Width	Limit	Limit	Width	Width	Limit		
	3.00 -	3.20 Hwy271	1056	EML	45	15	FULL WIDTH	15	45	EML	2.90	
	2.54 -	3.00 Hwy271	2428.8	EML	53		MEDIAN WALL		53	EML	10.00	
	0.65 -	6.62 I-540	31521.6	EML	63		MEDIAN WALL		63	EML	65.00	
	6.62 -	11.24 I-540	24393.6	EML	58	30	FULL WIDTH	30	58	EML	75.00	
	11.24 -	11.88 I-540	3379.2				RIVER BRIDGE					
	11.88	14.76 I-540	15206.4	EML	45	60	FULL WIDTH	60	45	EML	58.50	
		Interchanges L.M. No. *										
	14.76 @ I-40 on I-540			EML						EML	10.00	
	14.22 @ Hwy 64 on I-540			EML						EML	33.00	
	11.88 @ 4th St on I-540			EML						EML	10.00	
	9.81 @ Kelley Hwy on I-540			EML						EML	7.72	
	5.21 @ Leigh Ave on I-540			EML						EML	6.85	

NOTE: Width Measurements are Nominal and/or Average
 Acres Per Cycle 278.97
 EML = Established Mowing Lines (Based on Previous Mowing including Frontage Roads)

ARKANSAS STATE HIGHWAY AND TRANSPORTATION DEPARTMENT
 SUPPLY CONTRACT FOR MOWING AND TRIMMING OF HIGHWAY RIGHT OF WAY
 QUANTITIES FORM FOR ONE(1) MOWING CYCLE

Job No.:
 Route: I-540/Hwy 271
 Job Limits: L.M. 0.00/2.54 to L.M. 14.76/3.20
 Counties Crawford and Sebastian

Bidder: _____

Area Limits	Length (Feet)	Width(Ft.) & Limit of Mowing						Acres		
		Ramps			Ramps					
Log Mile to Log Mile:		Left	Width	Right	Limit	Left	Width	Right	Limit	
3.65 @ Hwy 255 on I-540		EML				EML				10.07
.65 @ Hwy 271 on I-540		EML				EML				6.95
2.06 @ 28th St. Overpass		15' along both sides of 28th Street						0.51		
Jenny Lind from ditch to right of way only		EML				EML				0.50
Additional Mowing Last Pass (25'-50' wide for transition - both sides of ramps and infields)										
11.88 @ 4th St on I-540										1.50
9.81 @ Kelley Hwy on I-540										1.50
		Additional Acres Last Cycle Only						3.00		

Acres Per Cycle 18.03

NOTE: Width Measurements are Nominal and/or Average Total for Hwy. 271 & 1540 297.00

EML = Established Mowing Lines (Based on Previous Mowing including Frontage Roads)

* List Each Interchange by L.M. No. and Acres to be mowed

**ARKANSAS STATE HIGHWAY AND TRANSPORTATION DEPARTMENT
SUPPLY CONTRACT FOR MOWING AND TRIMMING OF HIGHWAY RIGHT OF WAY
QUANTITIES FORM FOR ONE(1) MOWING CYCLE**

Job No.:

Route: 71 - 13& 14 & 14B

Job Limits: L.M. 7.40/0.00/0.00 to L.M. 10.25/9.83/1.12

Counties Sebastian

Bidder: _____

Area Limits	Length (Feet)	Width(Ft.) & Limit of Mowing						Acres		
		Left Main Lanes			Right Main Lanes					
		Left	Right	Limit	Left	Right	Limit			
Log Mile to Log Mile:	Hwy.	Limit	Width	Width	Limit	Limit	Width	Width	Limit	
7.40 -	10.25 71-13	EML	35	15	EML	EML	15	35	EML	34.54
0.00 -	1.75 71-14	EML	35	15	EML	EML	15	35	EML	21.21
1.75 -	9.83 71-14	EML	35	15	EML	EML	15	35	EML	97.94
0.00 -	1.12 71-14B	EML	30	15	EML	EML	15	30	EML	12.20

NOTE: Measurements are averages and include all good neighbor mowing

NOTE: Width Measurements are Nominal and/or Average

EML = Established Mowing Lines (Based on Previous Mowing including Frontage Roads)

* List Each Interchange by L.M. No. and Acres to be mowed

Acres Per Cycle on Hwy 71 165.89

Total Per Cycle (1st & 2nd Mowing) 462.89

Total Per Cycle (3rd Mowing) 465.89

Project Total 1391.67

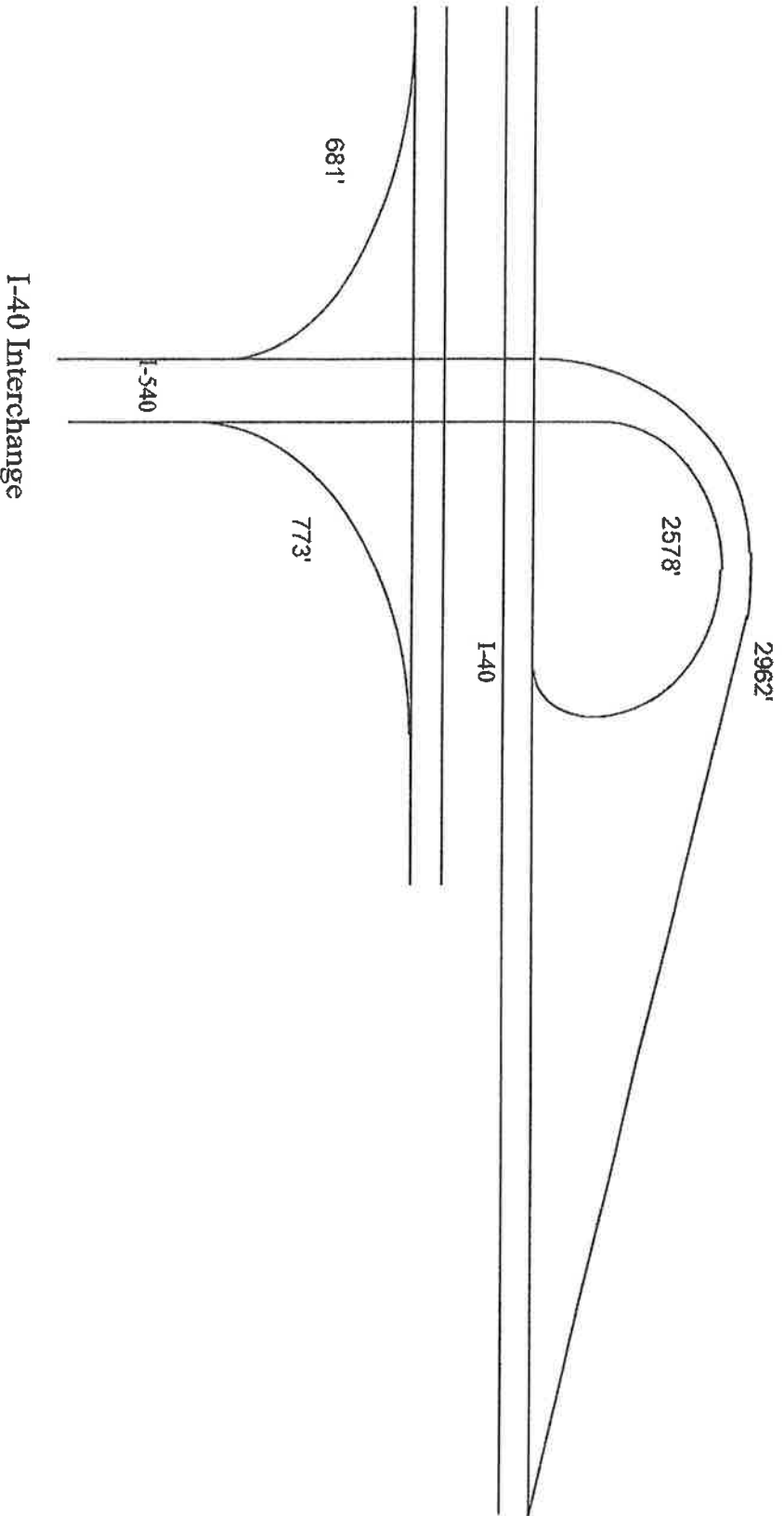

I-540 & Hwy 64

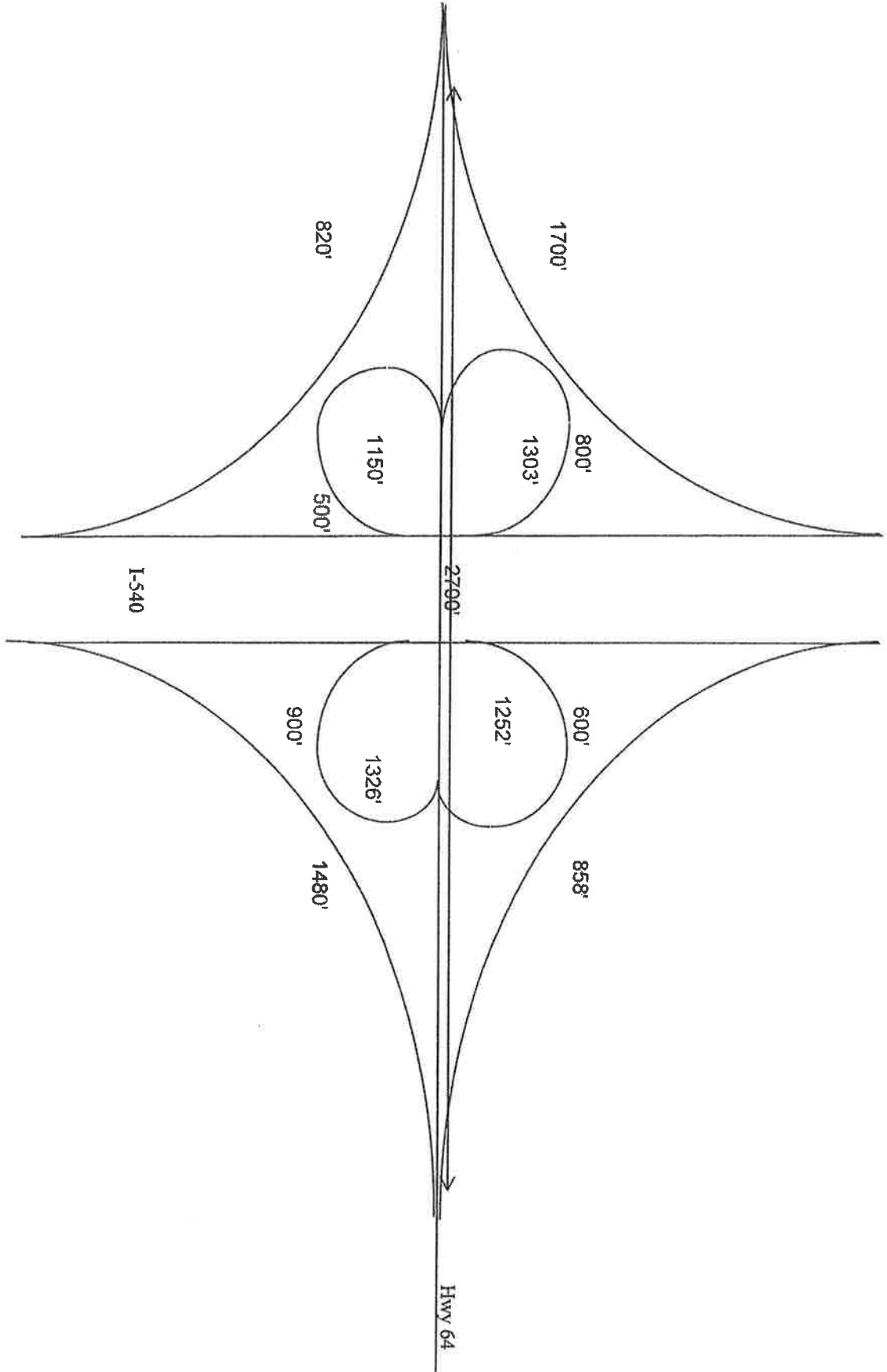

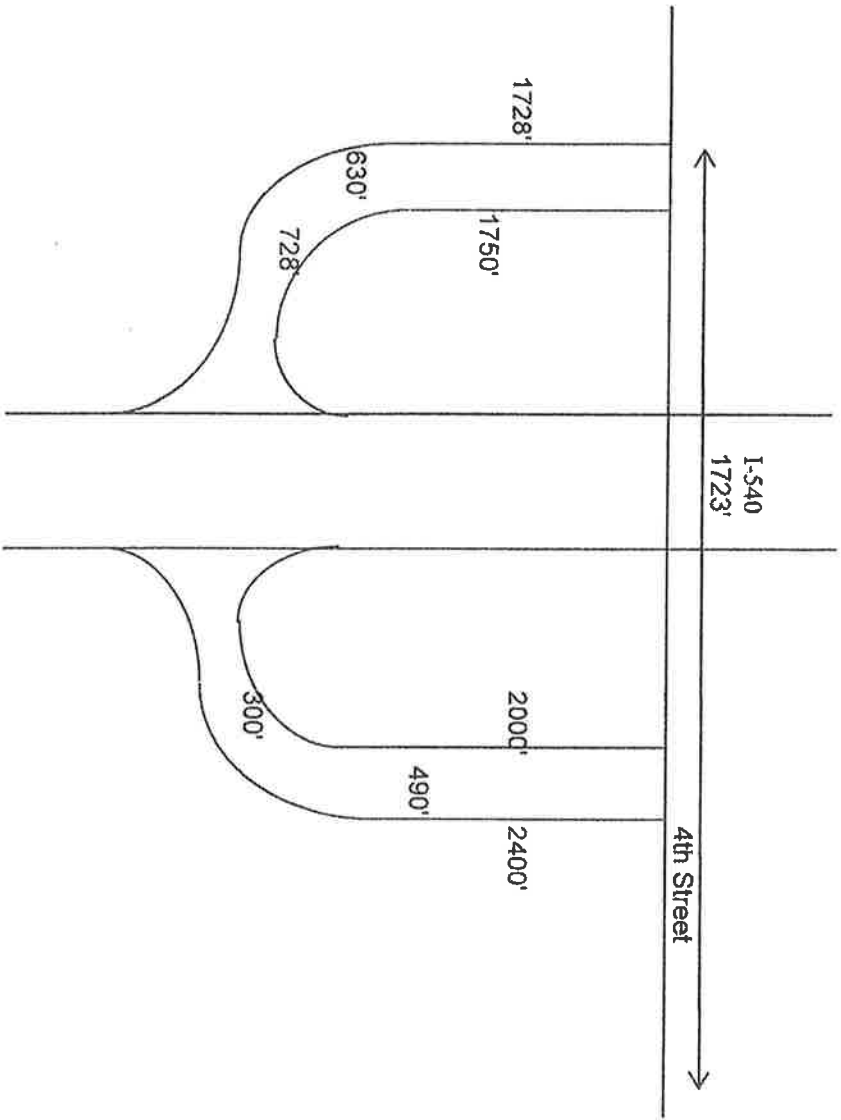

4th Street & I-540

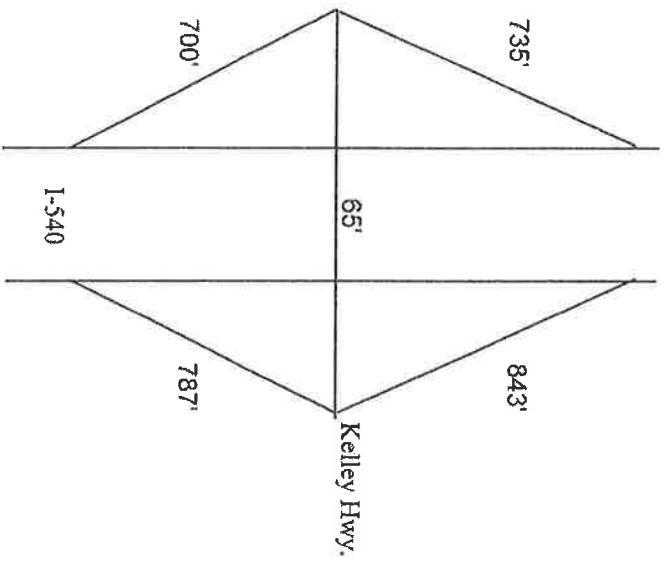

I-540 & Kelley Hwy.

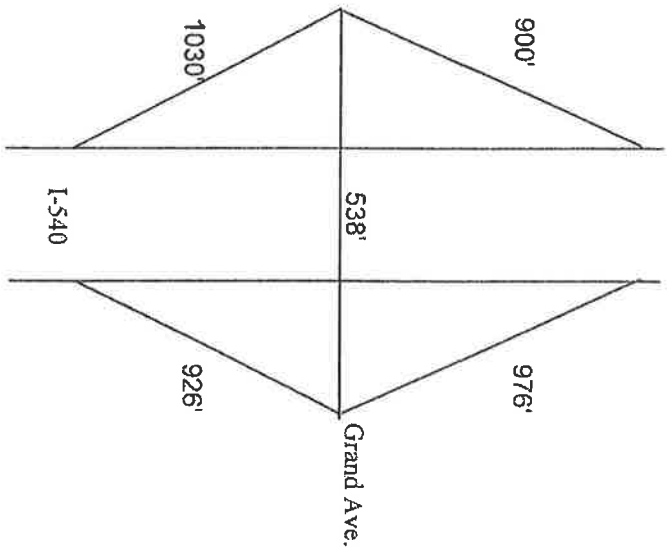

1540 & Grand Ave.

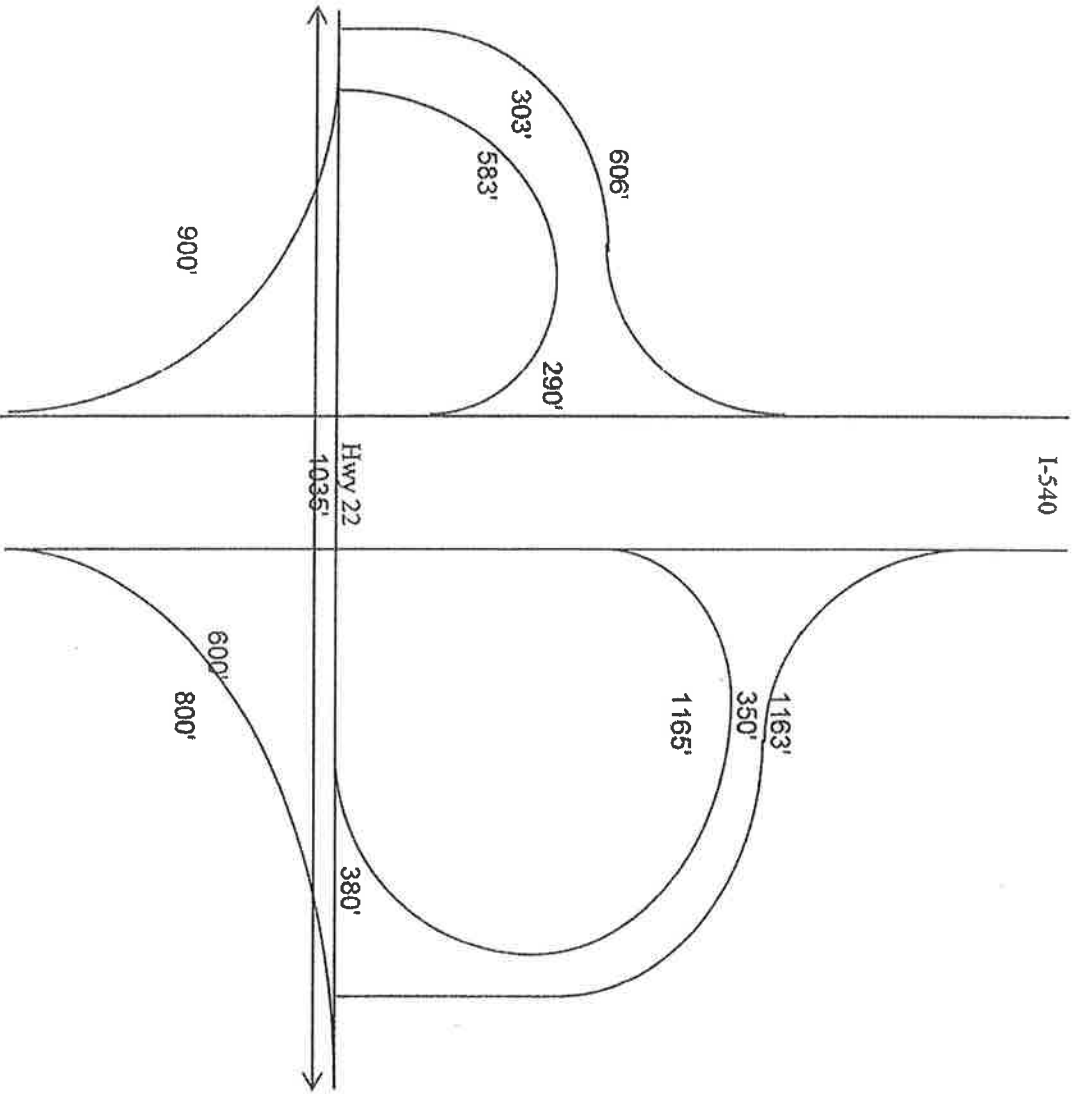

I-540 & Hwy 22 (Rogers Ave.)

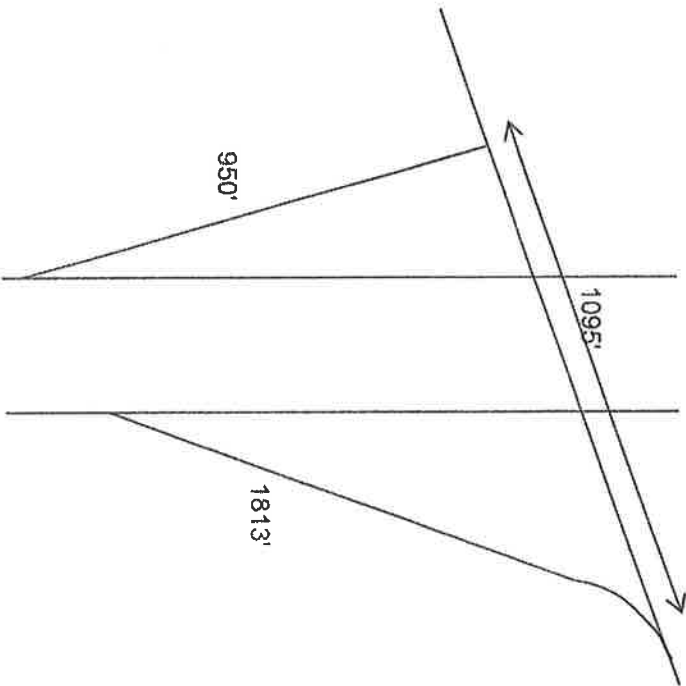

I-540 & Leigh Ave.

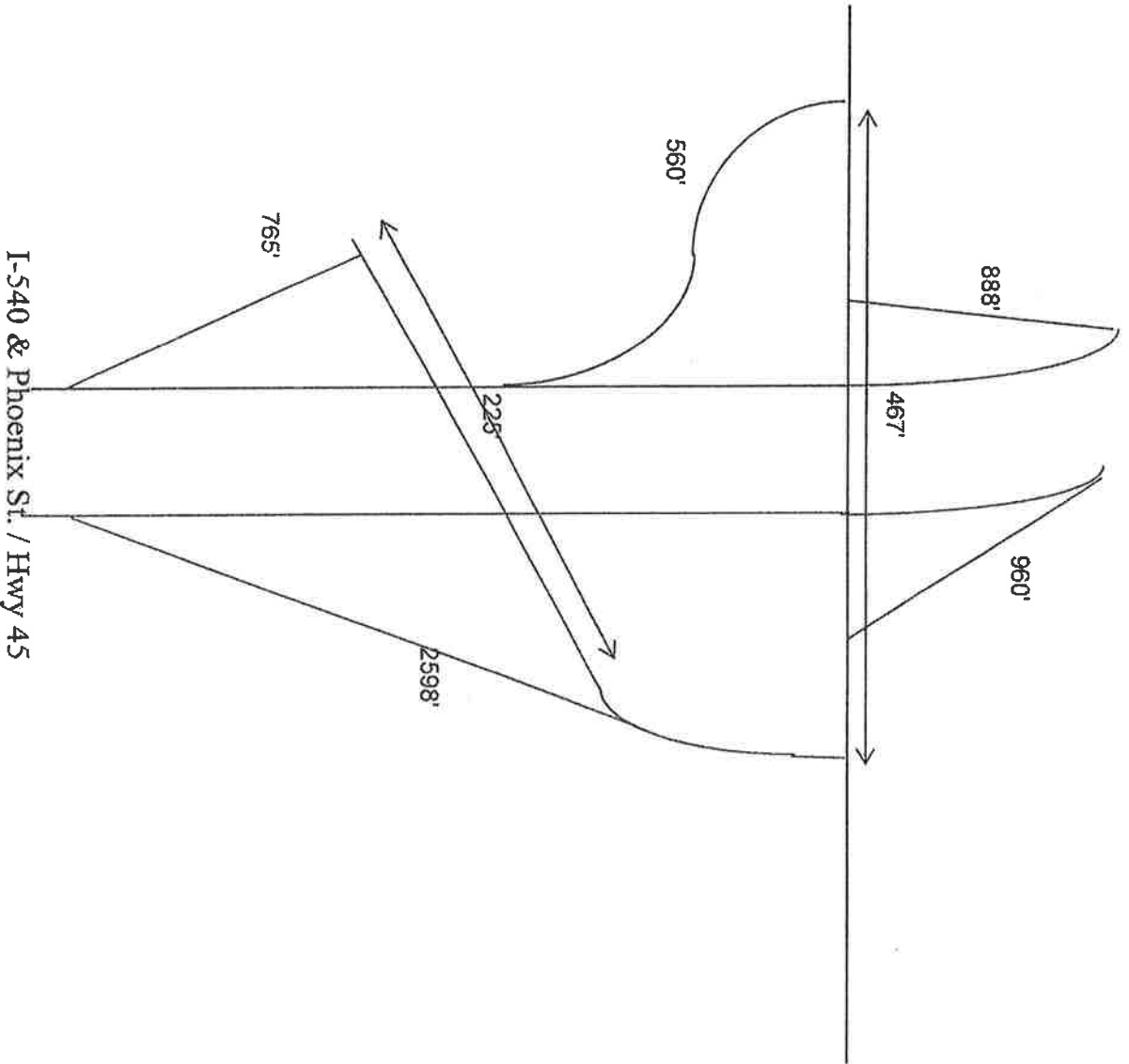

I-540 & Phoenix St. / Hwy 45

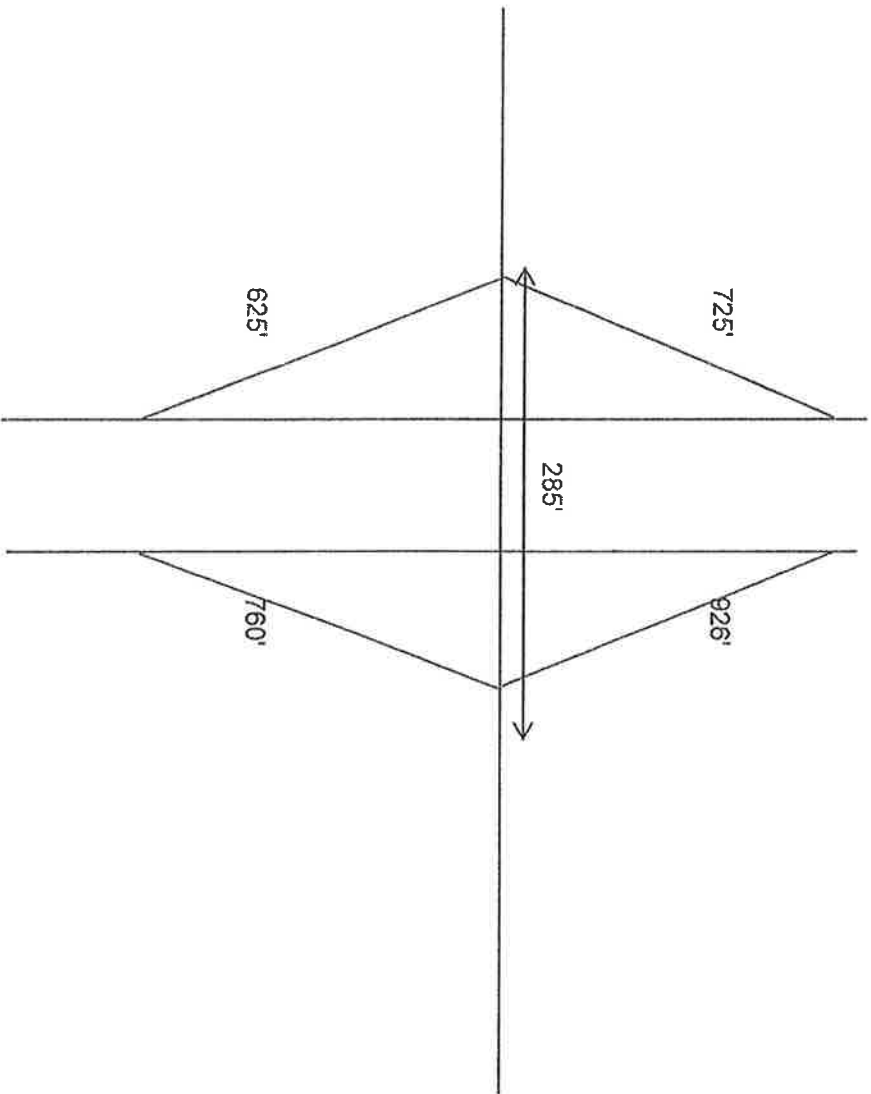

I-540 & Hwy 255 (Zero St.)

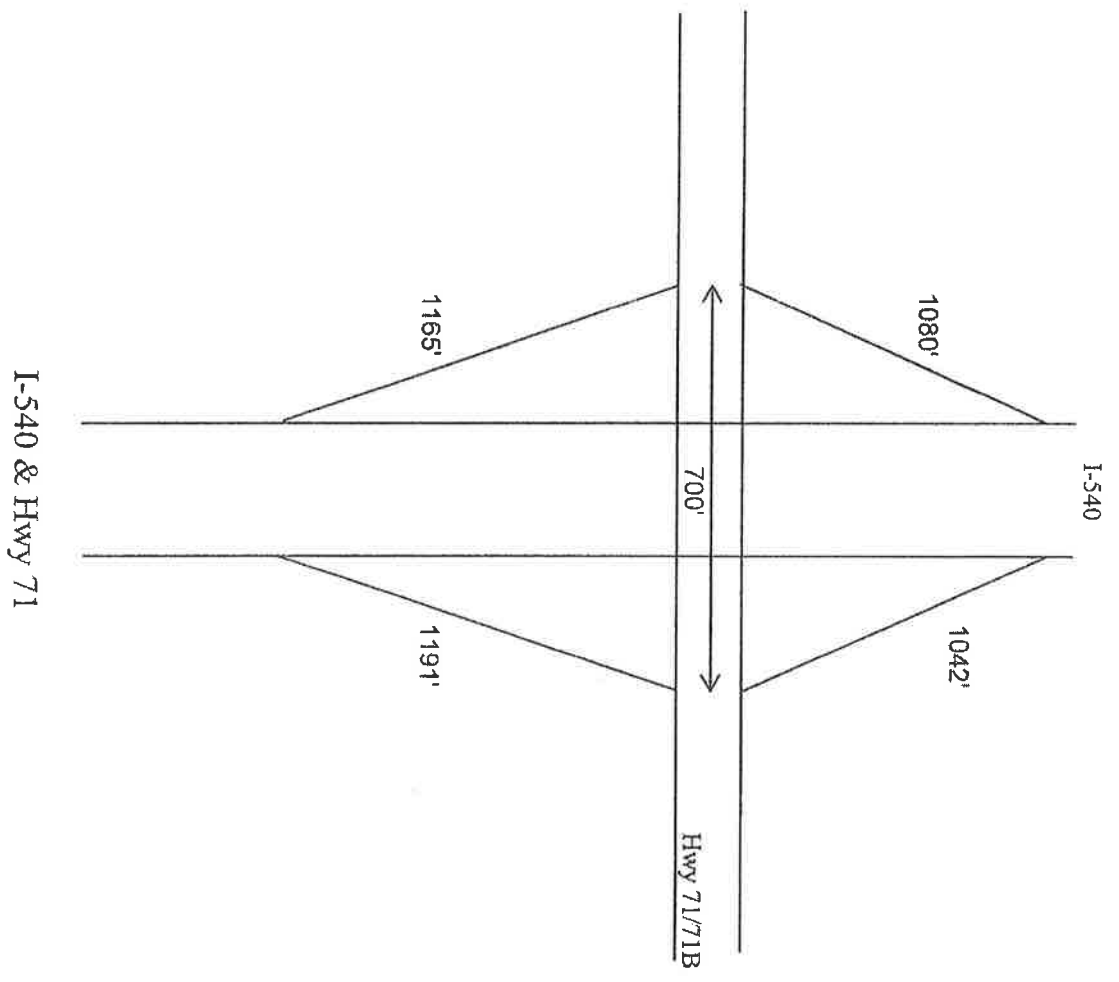

I-540 & Hwy 71

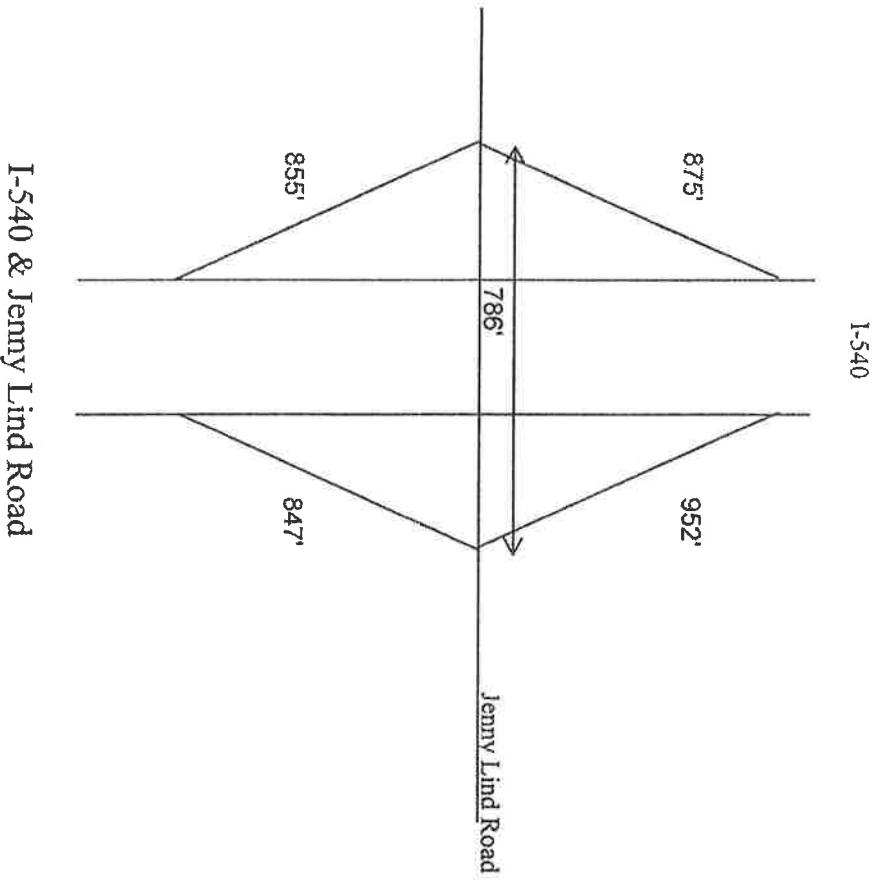

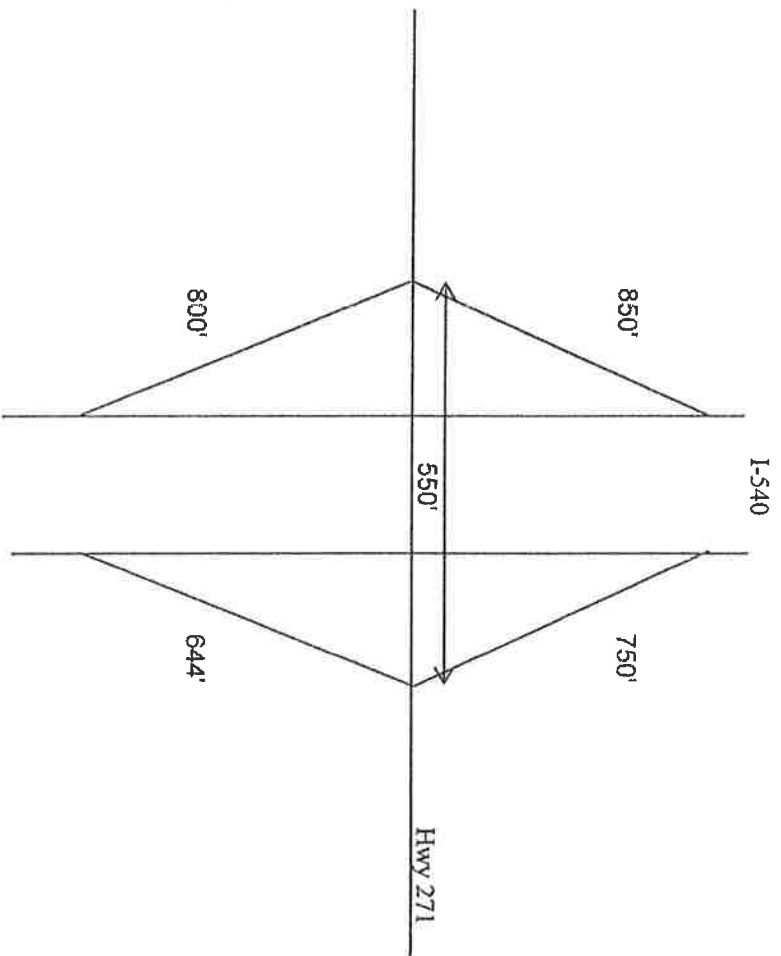

I-540 & Hwy 271

MOWING
CONTRACT
LIMITS

MOWING
CONTRACT
LIMITS

CONTRACT MOWING PROJECT
ROUTE: 271/1540/71/71B
CRAWFORD AND SEBASTIAN COUNTIES

