

Regulations For
Control Of

OUTDOOR ADVERTISING



This publication, REGULATIONS FOR CONTROL OF OUTDOOR ADVERTISING ON ARKANSAS HIGHWAYS, is issued under the authority of Arkansas State Highway Commission Minute Order 72-6, dated January 26, 1972, which Order directed the Commission to promulgate rules and regulations governing the erection of outdoor advertising signs, displays and devices along the National System of Interstate Highways and Federal Aid Primary Highways within the Arkansas State Highway System, and authorized the Director of the Arkansas State Highway Department to issue permits for the installation of outdoor advertising structures.

These regulations have been established in conformity with an Agreement between the Arkansas State Highway Commission and the United States Secretary of Transportation pursuant to Article I of Act 640 of the Acts of the General Assembly for the year 1967.

ARKANSAS STATE HIGHWAY DEPARTMENT

MINUTE ORDER

WHEREAS, Article I of Act 640 of the Acts of the General Assembly for the year of 1967 directs the Arkansas State Highway Commission to promulgate rules and regulations governing the erection of outdoor advertising signs, displays and devices along the National System of Interstate and Defense and Federal Aid Primary Highways within the Arkansas State Highway System; and

WHEREAS, the Arkansas State Highway Commission and the United States Secretary of Transportation have entered into an Agreement pursuant to said Act 640 of 1967 whereby the criteria for the erection of outdoor advertising signs, displays and devices along the National System of Interstate and Defense and Federal Aid Primary Highways within the Arkansas State of Highway System have been established;

NOW, THEREFORE, no outdoor advertising signs, displays or devices shall be erected within 660 feet* of any National System of Interstate and Defense and Federal Aid Primary Highways within the Arkansas State Highway System except by permit.

The Director of the Arkansas State Highway Department is hereby authorized to issue permits for the installation of outdoor advertising structures or devices within 660 feet of the National System of Interstate and Defense and Federal Aid Primary Highways within the Arkansas State Highway System in conformity with Act 640 of the Acts of the General Assembly of the State of Arkansas for the year of 1967 and the Agreement between the Arkansas State Highway Commission and the United States Secretary of Transportation dated the 24th day of January, 1972.

The charge for the issuance of permits shall be Forty Dollars (\$40.00).

*Superceded by Act 999 of 1975, See page 29.

AGREEMENT

FOR CARRYING OUT NATIONAL POLICY RELATIVE TO CONTROL OF OUTDOOR ADVERTISING IN AREAS ADJACENT TO NATIONAL SYSTEM OF INTERSTATE AND DEFENSE HIGHWAYS AND THE FEDERAL-AID PRIMARY SYSTEM.

THIS AGREEMENT made and entered into this 24th day of January, 1972 by and between the Secretary of Transportation acting by and through the Federal Highway Administrator and the Arkansas Highway Commission, represented by the Director of the Arkansas Highway Department.

WHEREAS, Congress has declared that outdoor advertising in areas adjacent to the Interstate and Federal-aid Primary systems should be controlled in order to protect the public investment in such highways, to promote the safety and recreational value of public travel and to preserve natural beauty; and,

WHEREAS, Section 131 (d) of Title 23, United States Code authorizes the Secretary of Transportation to enter into agreements with the several States to determine the size, lighting, and spacing of signs, displays, and devices, consistent with customary use, which may be erected and maintained within 660 feet* of the nearest edge of the right-of-way within areas adjacent to the Interstate and Federal-aide Primary Systems which are zoned industrial or commercial under authority of State law or in unzoned commercial or industrial areas, also to be determined by agreement; and,

*Superceded by Act 999 of 1975, See page 29.

WHEREAS, by passage of Act No. 640 by the 1967 Arkansas Legislature, the Arkansas Highway Commission, under Section 8 of said Act, has been authorized to enter into agreement with the Secretary for the purpose of controlling the erection and

maintenance of outdoor advertising in areas of the FAI and FAP Systems in Arkansas and to take action in the name of the State to comply with such agreement; and,

WHEREAS, the purpose of said agreement is to promote the reasonable, orderly, and effective display of outdoor advertising while remaining consistent with the National policy to protect the public investment in the Interstate and Federal-aid Primary Highways, to promote the safety and recreational value of public travel and to preserve natural beauty; and,

WHEREAS, the State of Arkansas desires to implement and carry out the provisions of Section 131 of Title 23, United States Code, and the National policy in order to remain eligible to receive the full amount of all Federal-aid highway funds to be apportioned to Arkansas on or after January 1, 1968, under Section 104 of Title 23, United States Code.

NOW THEREFORE, the parties hereto do mutually agree to the following:

1. DEFINITION:

For purposes of making these determinations, the following definitions apply

- A. *Sign* means an outdoor sign, display, device, figure, painting, drawing, message, placard, poster, billboard, or other thing which is designed, intended, or used to advertise or inform, any part of the advertising or informative contents of which is visible from any place on the main traveled way of the Interstate or Federal-aid Primary Highway.
- B. *Traveled way* means the portion of the roadway for the movement of vehicles, exclusive of shoulders.
- C. *Main traveled way* means the through traffic lanes exclusive of frontage roads, auxiliary lanes, and ramps.
- D. *Erect* means to construct, build, raise, assemble, place, affix, attach, create, paint, draw, or in any other way bring into being or establish a sign but excluding customary maintenance

or repair and the activities incident to the change of advertising messages on established signs or sign structures.

E. *The term "Act"* means Section 131 of Title 23, United States Code (1965) commonly referred to as Title I of the Highway Beautification Act of 1965.

F. *Commercial or industrial activities* mean those activities generally recognized as commercial or industrial by public zoning authorities in Arkansas, except that none of the following activities shall be considered commercial or industrial:

1. Outdoor advertising structures.
2. Agricultural, forestry, grazing, farming, and similar activities, including, but not limited to, wayside fresh produce stands.
3. Transient or temporary activities.
4. Activities not visible from the main traveled way.
5. Activities more than 660 feet from the nearest edge of the right-of-way.
6. Activities conducted in a building principally used as a residence.
7. Railroad tracks and minor sidings, except in the area of a permanent facility for loading and unloading trains.

G. *Zoned commercial or industrial areas* mean those areas which are zoned commercial, or industrial by a recognized public zoning authority.

H. *Unzoned commercial, business, or industrial areas* means the land occupied by the regularly used building, parking lot, and storage or processing area of a commercial, business, or industrial activity, and that land within 600 feet thereof on both sides of the highway. The unzoned land shall not include:

1. Land on the opposite side of an interstate or primary freeway highway from an unzoned commercial, business, or industrial area, as defined above.
2. Land predominantly used for residential purposes.
3. Land zoned by state or local law, regulation, or ordinance.
4. Land on the opposite side of a non-freeway primary highway which is deemed scenic by the State Highway Department.

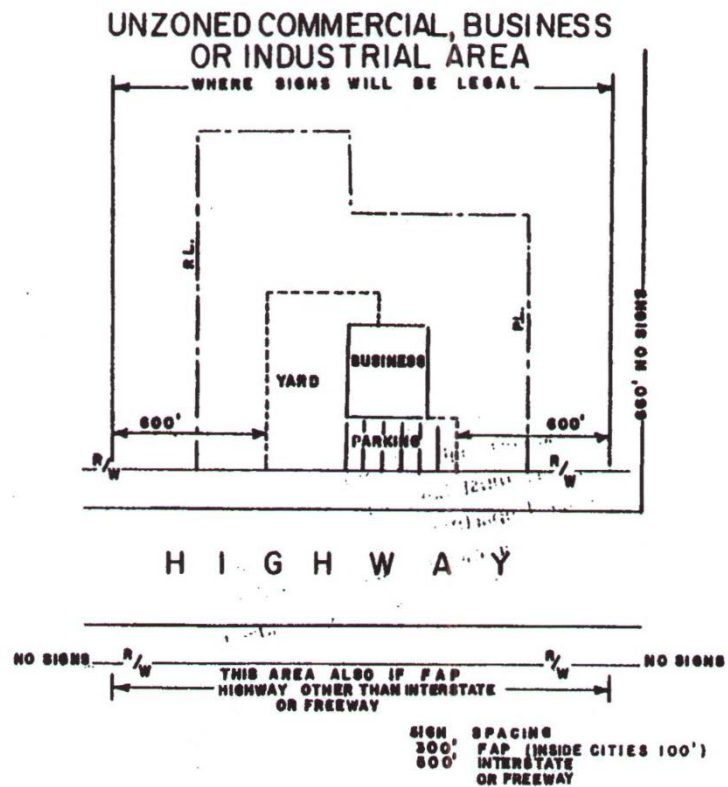

- I. *Municipalities* means those incorporated areas defined by an established city limits.
- J. *Auxiliary lane* means that portion of the roadway adjoining the traveled way for speed change, turning or for other purposes supplementary to through traffic movement. (Auxiliary lanes shall include, but not be limited to, acceleration and deceleration lanes, turning lanes and climbing lanes.)
- K. *Ramps* shall mean a turning roadway, not adjoining the traveled way, and connecting two or more legs of an intersection or interchange and shall be that section between gores, beginning and ending of auxiliary lanes, and terminal connection with an intersecting roadway or combination thereof.
- L. *Freeway* means a divided arterial highway for through traffic with full control of access.

II. SCOPE OF AGREEMENT

This agreement shall cover the determination of standards and criteria for size, lighting, and spacing of signs permitted in zoned or unzoned commercial and industrial areas, and the established definition of unzoned industrial and commercial areas for the effective control of the erection and maintenance, along the Interstate System and the FAP System in the State of Arkansas, of outdoor advertising signs which are within 660 feet* of the nearest edge of the right-of-way and visible from the main traveled way of the systems; and,

Those determinations set forth in this agreement have been established with consideration to the customary use in the outdoor advertising industry in Arkansas and are no more restrictive than that required by Title 23, United States Code and do not apply to (a) on premise advertising, official and directional signs, identification markers as permitted under Section 131 (c) of Title 23, United States Code and Subsections 5 c, d, and e of the Arkansas Act 640; (b) all outdoor advertising signs legally erected and maintained, in zoned and unzoned commercial and industrial areas established by this agreement, on FAP and FAI Highways prior to the date of enactment of this agreement; (c) outdoor advertising signs legally erected and maintained in zoned or unzoned commercial and industrial areas established by this agreement on highways which become a part of the FAP and FAI System after the date of this agreement.

III. DETERMINATION OF SIGN STANDARDS AND CRITERIA FOR CONTROL OF OUTDOOR ADVERTISING:

A. *General*

The following signs shall not be permitted:

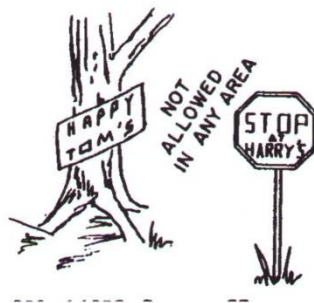

*Superseded by Act 999 of 1975, See page 29.

1. Signs which imitate or resemble any official traffic sign, signal, or device.
2. Signs which are erected or maintained upon trees or painted or drawn upon rocks or other natural features.
3. Signs which are structurally unsafe or in disrepair.

B. *Size of Signs*

1. A sign structure may consist of two facings so long as only one facing is visible from the approaching traveled way.
2. A sign structure may contain one or two signs per facing and not more than four signs per structure.

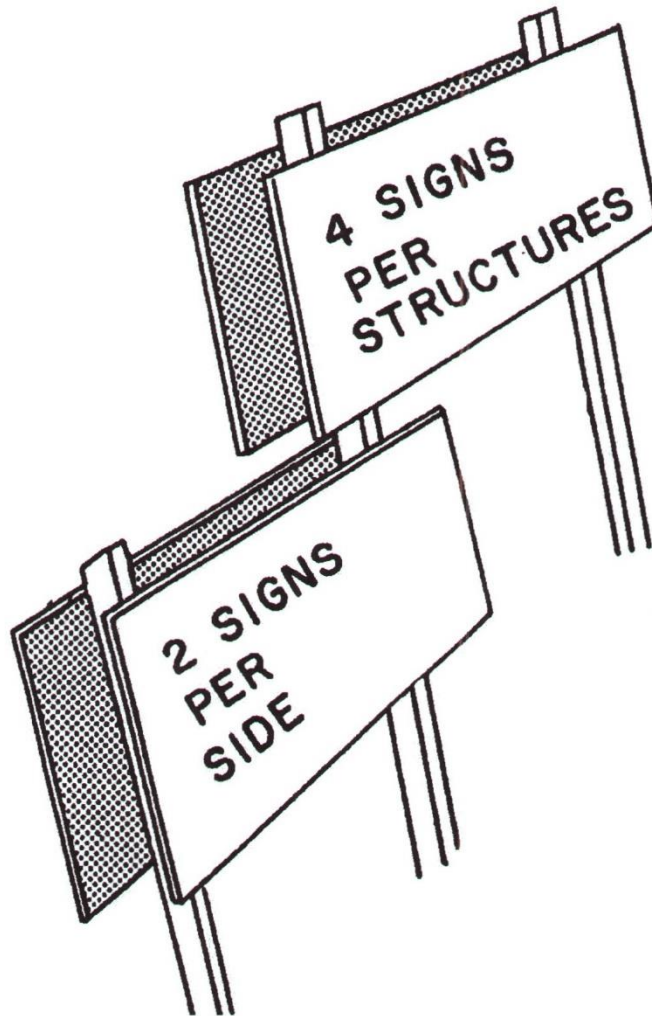

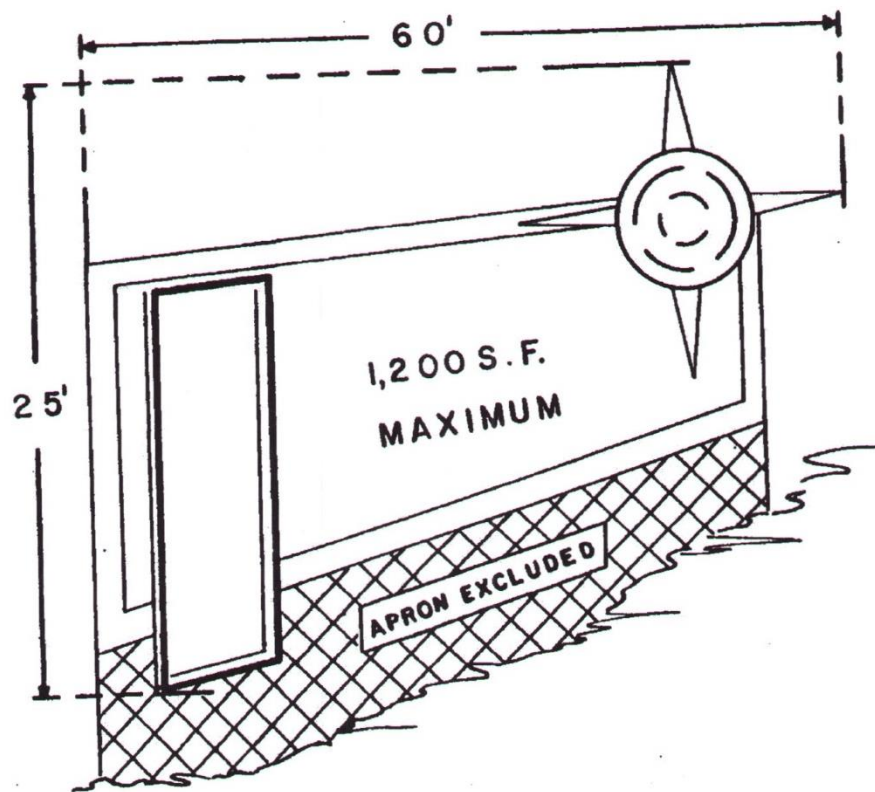

3. The maximum area of a single sign on one facing shall be 1,200 square feet and a maximum length of 60 feet and maximum height of 25 feet inclusive of any border and trim but excluding ornamental base or apron supports and other structural members.
4. When two signs are placed on one facing, the maximum area per each sign will be 550 square feet with a maximum combined length of 70 feet and a maximum combined height of 35 feet inclusive of any border and trim but excluding ornamental base or apron supports and other structural members.
5. The length will be measured at the maximum horizontal span including cutouts and trim and will include the space between signs when two signs are placed on one facing.

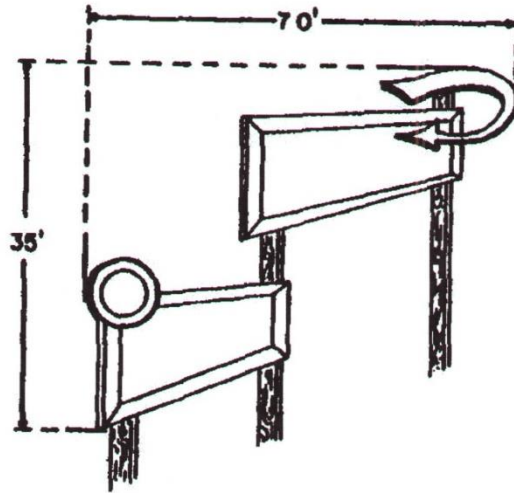

6. The height shall be measured from the lowest and highest points including cutouts and trim on the sign or two signs, regardless of the facing on which they are located, and shall include the space between signs when one sign is placed over another sign on one facing.

C. *Spacing of signs*

1. Interstate and primary highways:
 - (a) Signs may not be located in such a manner as to obscure, or otherwise interfere with the effectiveness of an official traffic sign, signal, or device, or obstruct or interfere with the driver's view of approaching, merging, or intersecting traffic.
2. Interstate Highways and Freeways on the Federal-aid Primary System:
 - (a) No two structures shall be spaced less than 500 feet apart.
 - (b) In areas outside municipalities, no structure may be located within the area immediately adjacent to an interchange, an auxiliary lane or ramp, and within 500 feet from the beginning or ending of the pavement widening at the exit from or entrance to the main traveled way.
3. Non-Freeway Federal-aid Primary Routes:
 - (a) Outside of Municipalities – no two structures shall be spaced less than 300 feet apart.
 - (b) Inside Municipalities – no two structures shall be spaced less than 100 feet apart.

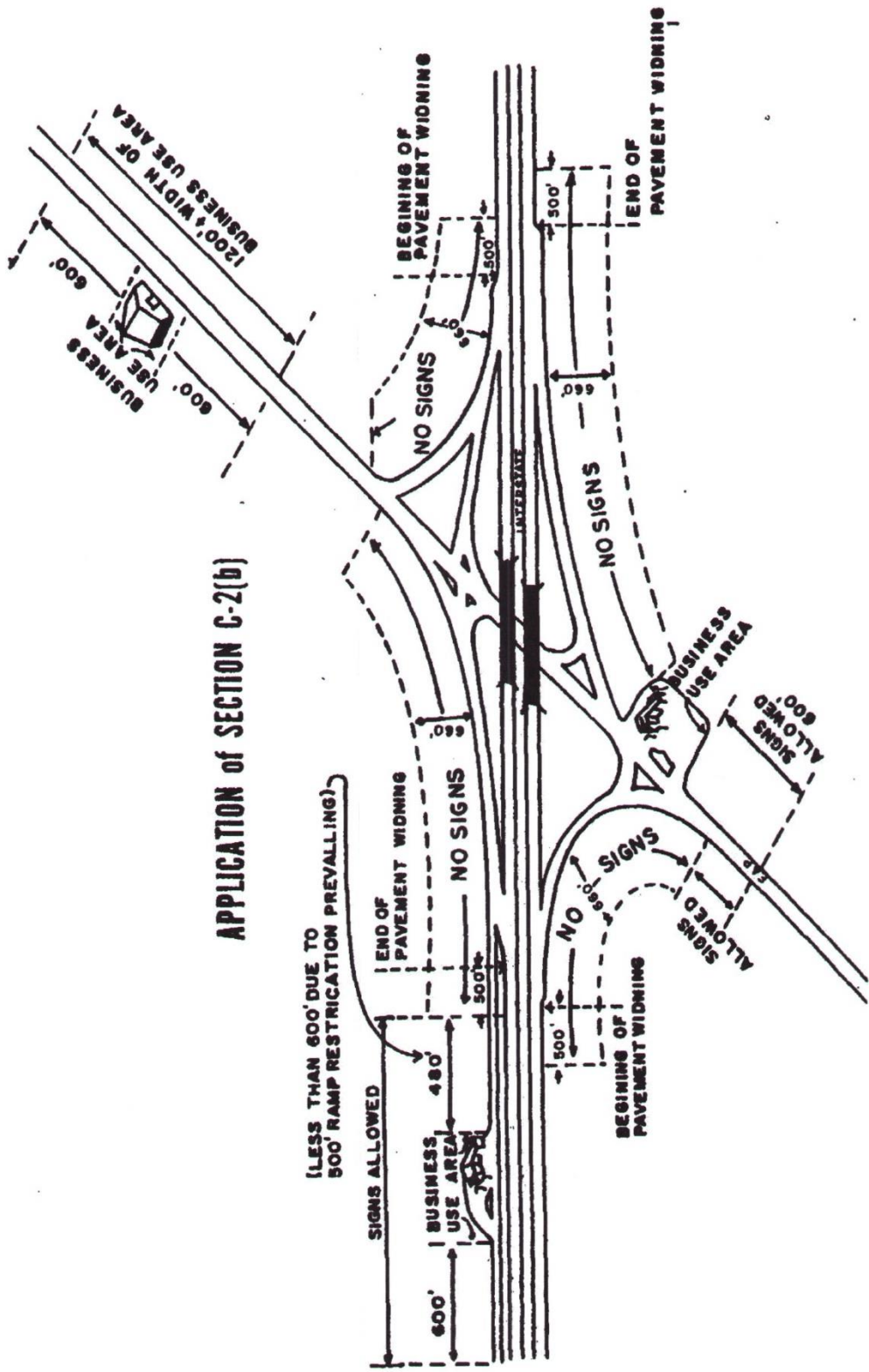

APPLICATION OF SECTION C-2(b)

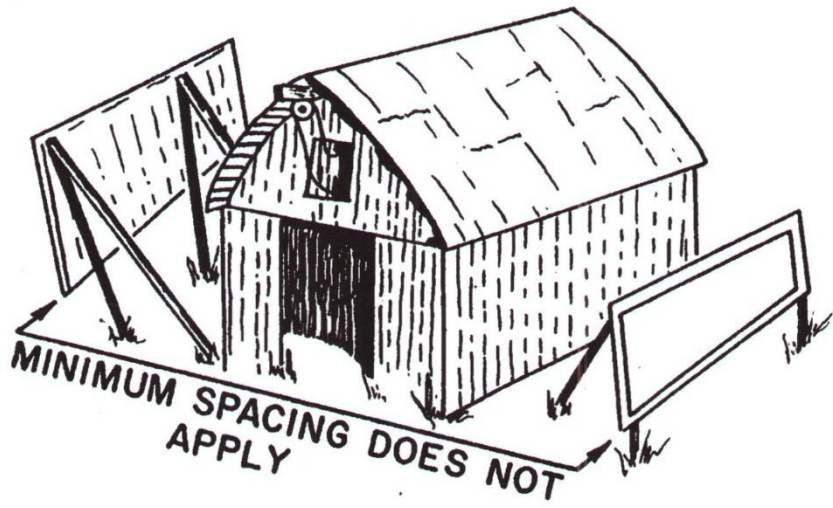

4. These minimum spacings do not apply to sign structures separated by buildings or other obstructions in such a manner that only one sign structure is visible from the highway at any one time.
5. Explanatory Notes:
 - (a) Alleys, undeveloped rights-of-way, private roads and driveways shall not be regarded as intersecting streets, roads or highways.
 - (b) Only roads, streets and highways which enter directly into the main traveled way of the primary highway shall be regarded as intersecting.
 - (c) Official and "on premise" signs, as defined in Section 131 (c) of Title 23, United States Code, and subsections 5 c, d, and e of the Arkansas Act shall not be counted nor shall measurements be made from them for purposes of determining compliance with these sign spacing requirements.
 - (d) Outdoor advertising signs legally erected prior to the date of enactment of this agreement will be counted and measurements made from them for purposes of determining the spacing of signs erected after the date of enactment of this agreement.

- (e) The minimum distance between signs shall be measured along the nearest edge of the pavement between points directly opposite the signs and each side of the highway will be considered separately.

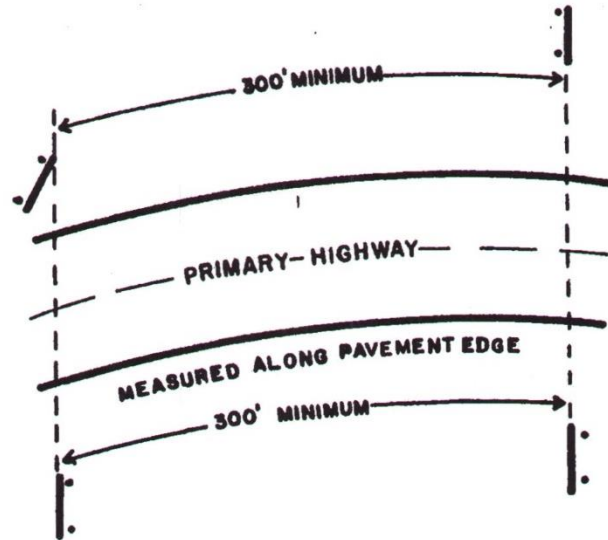

D. *Lighting*

Signs may be illuminated, subject to the following restrictions:

1. Signs which contain, include, or are illuminated by any flashing, intermittent, or moving light or lights are prohibited, except those giving public service information such as time, date, temperature, weather, or similar information.
2. Signs which are not effectively shielded as to prevent beams or rays of light from being directed at any portion of the traveled ways of the Interstate or Primary highways and which are of such intensity or brilliance as to cause glare or to impair the vision of the driver of any motor vehicle, or which otherwise interferes with any driver's operation of a motor vehicle are prohibited.
3. No sign shall be so illuminated that it interferes with the effectiveness of, or obscures an official traffic sign, device, or signal.

TYPICAL ALLOWABLE SIGN LOCATIONS

■ BUSINESS,
INDUSTRIAL,
COMMERCIAL

----- SIGNS ALLOWED

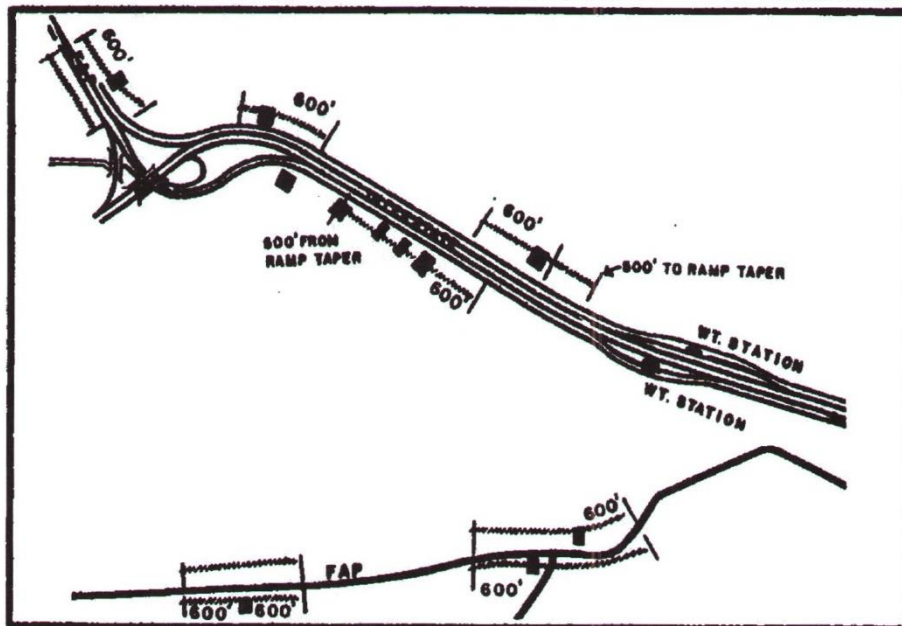
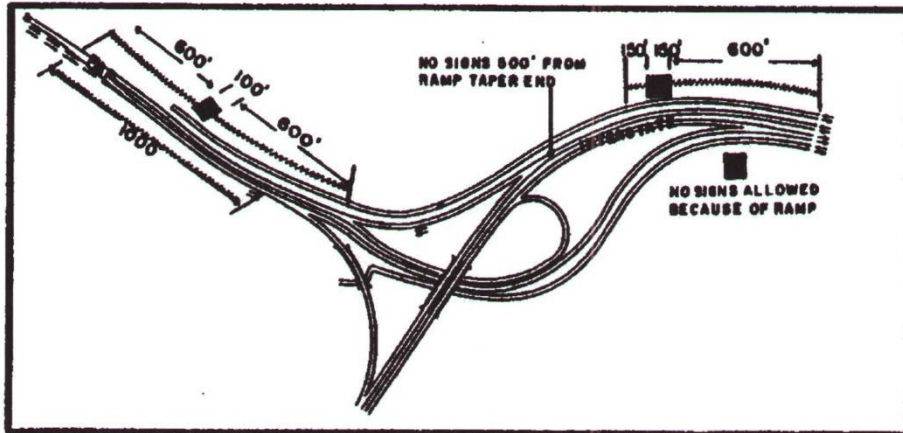
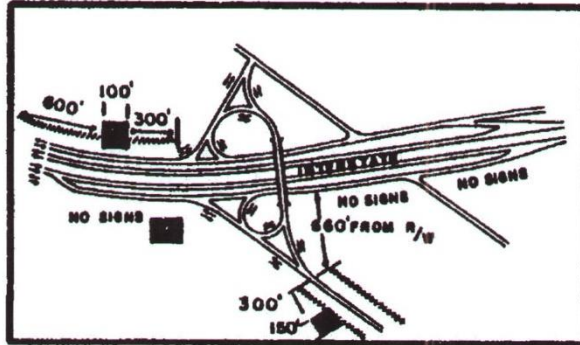

TYPICAL ALLOWABLE SIGN LOCATIONS

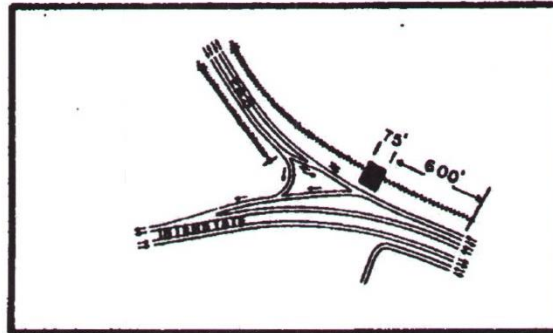

 BUSINESS,
 INDUSTRIAL,
 COMMERCIAL

 SIGNS ALLOWED

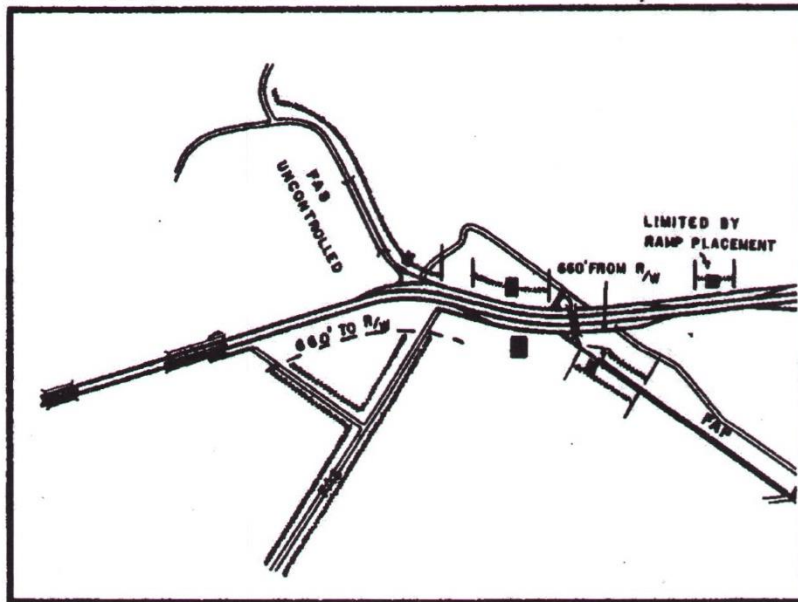
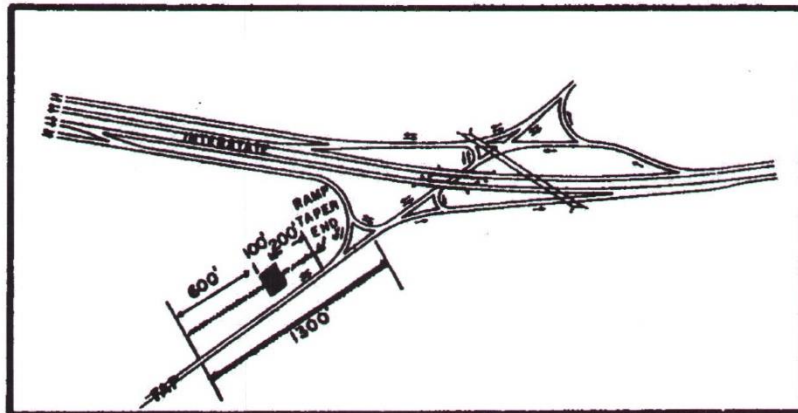

E. *Zoning authority*

The State of Arkansas and local political subdivisions shall have full authority under their own zoning laws to zone areas for commercial or industrial purposes and the action of the State and local political subdivisions in this regard will be accepted for the purposes of this agreement. At any time that a political subdivision adopts comprehensive zoning which includes the regulating of the size, lighting, and spacing of outdoor advertising signs within the zoned commercial and industrial areas consistent with the purposes of the Highway Beautification Act of 1965 and with customary use the Arkansas Highway Commission may certify to the Administrator as notice of effective control of signs within the zoned area.

IV. STATE CONTROL

The Arkansas Highway Commission hereby agrees that in accordance with the scope of this agreement, the Commission shall effectively control, or cause to be controlled, the erection and maintenance of outdoor advertising signs.

V. CONDITIONS

- A. It is further agreed that these determinations are based on the contents and requirements of the Highway Beautification Act of 1965 as it exists on this date and that any amendment or interpretation of said Act modifying the requirements for the States will automatically provide the Arkansas State Highway Commission the option of revising this agreement to reflect the latest revisions or interpretations.
- B. It is hereby agreed that the State will not be required to remove any tourist-oriented sign, display or device until the Highway Beautification Commission submits its report and recommendation to the Congress of the United States.
- C. It is mutually understood that no sign, display, or device will be required to be removed under this agreement if the Federal share of the just compensation to be paid upon removal of such sign, display, or device is not available to make such payment.

VI. EFFECTIVE DATE

This agreement shall become effective on the date that it is approved by the Federal Highway Administrator.

IN WITNESS WHEREOF the parties hereto have caused this agreement to be duly executed as of the date specified.

January 14, 1972

ARKANSAS STATE HIGHWAY COMMISSION

By /s/ Ward Goodman

Director of Highways
Arkansas State Highway Department

January 24, 1972

SECRETARY OF TRANSPORTATION

By /s/ Francis B. Turner

Federal Highway Administrator

HOW TO OBTAIN PERMIT

Permit applications may be obtained from the Environmental Division's Beautification Section, Arkansas State Highway and Transportation Department, P.O. Box 2261, Little Rock, Arkansas, 72203.

Completed applications for signs in legal zones should be submitted to the Environmental Division, Beautification Section, P.O. Box 2261, Little Rock, Arkansas 72203.

Applications must include a \$40 fee for each sign (check or money order, no cash.) Separate checks shall be sent for each application.

Upon application for a permit, the sign owner must arrange with the State Inspector to show the exact location for the proposed device. This must be accomplished by either an on-site visit by the sign owner's representative or by an easily visible stake or marker.

Information will be reviewed and a permit will be issued for signs that comply with all regulations.

If signs do not comply, fees will be returned with a brief explanation concerning the reason for permit refusal.

After 30 days from issuance of permit, the State's Inspector will review the device and if it complies with all regulations, affix a permit decal to the structure. If a device has not been erected within 120 days from the issuance of the permit, the permit will no longer be valid.

Signs without a permit decal are not valid. Permit markers for Class A permits and Class B permits will be of different colors.

Class A permits will expire on December 31 of odd number years (2007, 2009, 2011, etc.). Class B permits will expire on December 31 of even numbered years (2006, 2008, 2010, etc.). Renewal applications must be received by the Arkansas State Highway and Transportation Department, Beautification Section, by December 31 of such years. The renewal fee for a Class A outdoor advertising permit shall be \$20.00. The renewal fee for a Class B permit shall be \$30.00.

By December 1 of such year, a notice of renewal will be sent to the permit-owner.

Commencing December 2006, and each year thereafter, if the renewal application and fee are not received from the permit-owner by December 31, a second renewal notice will be sent to the permit-owner granting until January 31 to renew the permit.

If the renewal application and fee are not received from the permit-owner by January 31, a third renewal notice will be sent by certified mail stating that the permit has

expired and a renewal application and fee must be received by the Arkansas State Highway and Transportation Department by the thirtieth day after January 31. Weekends and holidays shall be included when calculating the 30-day period.

If the renewal application and fee are not received from the permit-owner by the thirtieth day after January 31, then the sign must be removed.

It shall be the responsibility of the permit-owner, and not the Arkansas State Highway and Transportation Department, to provide the appropriate mailing address for renewal notification.

REVISED REGULATIONS FOR ISSUANCE OF PERMITS FOR
OUTDOOR ADVERTISING DEVICES AND SIGNS

SECTION 1. As used in these regulations the term:

- A. *“Outdoor advertising device”* means any outdoor sign, display, figures, painting, drawing, message, plaque, poster, billboard, or other thing, hereinafter referred to as “device”, which is designated, intended, or used to advertise, any part of the advertising of which is visible from any place on the main traveled way of the Interstate, or Primary Highways.
- B. *“Sign”* means an outdoor display, device, figure, painting, drawing, message, placard, poster, billboard, or other thing which is designated, intended, or used to advertise or inform, any part of the advertising or informative contents of which is visible from any place on the main traveled way of the Interstate or Federal-aid Primary Highway.
- C. *“Agreement”* means the agreement between the Arkansas State Highway Commission and the United States Secretary of Transportation executed on January 24, 1972, pursuant to Article I of Act 640 of the Acts of the 1967 Arkansas General Assembly, which agreement established standards and criteria for size, lighting, and spacing of signs permitted in zoned or unzoned commercial and industrial areas within 660 feet of Interstate or Primary Highways in Arkansas*, and which defined unzoned and commercial and industrial areas.
- D. *“Manual”* means the pamphlet published by the Arkansas State Highway Commission setting out and exemplifying the requirements of the Agreement, entitled Regulations for Control of Outdoor Advertising, authorized by Commission Minute Order 72-6, dated January 26, 1972.
- E. *“Conforming outdoor advertising device”* means a device which is in conformity with the requirements of the Act 640.
- F. *“Nonconforming outdoor advertising device”* means a device which does not conform to the requirements of the Act 640.
- G. *“Illegal outdoor advertising device”* means a device erected and/or maintained in violation of the law.
- H. *“Erect”* means to construct, build, raise, assemble, place, affix, attach, create, paint, draw, or in any other way bring into being or establish a device or sign or sign structure as defined, by the Agreement, but excluding customary maintenance or

*Superseded by Act 999 of 1975, See page 29.

repair and the activities incident to the change of advertising messages on established devices or sign structures.

- I. “*Customary maintenance or repair*”. The following activities are considered to fall within the meaning of customary maintenance or repair and copy change:
- (1) The routine replacing of border and trim as well as repair of structural members and replacing of structural members destroyed by an outside force other than normal deterioration. Re-erection of a device rendered unfunctional within the definition of “device” herein is specifically prohibited as customary maintenance except as provided in the last paragraph of Section 3 herein. The raising or lowering of the height of a sign structure as a result of any repair is specifically prohibited.
 - (2) Slight temporary alterations of some of the outside dimensions of painted bulletin boards incidental to copy change, which do not substantially increase the overall dimensions of the advertising copy portion of the device.
 - (3) Any net decrease in the outside dimensions of the advertising copy portion of the device will be permitted. Any subsequent change in the outside dimensions of the panel will be permitted so long as it does not exceed the actual dimensions the State and owner’s records indicate existed when the device was permitted. In no case, however, will legal size limitations be exceeded.
 - (4) The placing of night time illumination on existing sign structures is specifically prohibited as customary maintenance, except in such cases where the sign owner will sign a waiver of any future compensation as applies to illumination; however, such illumination may be permanently removed from such sign structure.
- J. “*Comprehensive zoning*” means a zoning plan established by State or local law, regulation or ordinance, which includes regulations consistent with customary use and the provisions of the agreement controlling the erection and maintenance of signs in the zoned areas. Except that, any area determined by the Department to be included in the area of such a zoning plan solely for the purpose of allowing outdoor advertising does not come within this definition.

- K. “*National Standards*” means those standards promulgated by the Secretary of Transportation and published in 23 CFR 21 setting standards for regulation of State of Directional and other Official Signs adjacent to the National System of Interstate and Defense Highways.
- L. “*Tri-Vision sign*” means a single faced sign having a series of three-sided, vertical slats arranged side by side which are rotated in the same direction, simultaneously, by an electric-mechanical process displaying a total of three separate and distinct messages, one message at a time. Tri-Vision signs are approved by permit prior to installation and are subject to the following:
- (1) The slat twirl time shall be two (2) seconds or less.
 - (2) The slat dwell time shall be eight (8) seconds or more.
 - (3) Tri-Vision signs shall contain a default design that will freeze the sign in one position if a malfunction occurs.
 - (4) Tri-Vision signs shall comply with all other requirements of Federal and State Highway Beautification laws and regulations.

SECTION 2.

On or after October 1, 1972, any existing device within 660 feet* of the nearest right-of-way limit of any Interstate or Primary highway must have a permit issued by the Arkansas State Highway Department evidenced by a permit marker affixed to a post or member supporting the device. Permits shall not be required for signs exempt under Par. 6 of these regulations.

SECTION 3. Permits shall be issued in two classes, as follows:

Class A Permits are issued for conforming devices and for any alteration thereof which is not customary maintenance. Class A Permits are granted upon condition that the permitted device will be removed at the owner’s expense should its location either now or at any future date violate any provisions of Act 640 of the General Assembly of Arkansas for the year 1967, or rules and regulations promulgated pursuant thereto. Nothing in this regulation is intended to require the removal of signs at the owner’s expense for which Act 640 of 1967 provides that just compensation be paid.

Class B Permits are issued for the maintenance of existing nonconforming devices until they are required to be removed under the provisions of Article 1, Section 7, or Act 640 of 1967. Issuance of a permit for an existing nonconforming device shall not be considered to be a determination of the eligibility and entitlement, or non-eligibility of

the device for compensation if the device is later required by law to be removed.

Devices for which a permit has been issued are subject to customary maintenance or repair as defined herein, but re-erection of a device rendered unfunctional is specifically prohibited on any nonconforming device erected after the effective date of Act 640. New permits will be issued to re-erect conforming devices rendered unfunctional and to re-erect those nonconforming devices rendered unfunctional which were erected prior to the effective date of the Act, or those in existence along secondary highways added to the primary system.

*Superceded by Act 999, See Page 29.

SECTION 4.

Permit applications may be obtained from the Environmental Division's Beautification Section, Arkansas State Highway and Transportation Department, P.O. Box 2261, Little Rock, Arkansas, 72203.

Completed applications for signs in legal zones should be submitted to the Environmental Division, Beautification Section, P.O. Box 2261, Little Rock, Arkansas, 72203.

Applications must include a \$40 fee for each sign (check or money order, no cash.) Separate checks shall be sent for each application.

Upon application for a permit, the sign owner must arrange with the State Inspector to show the exact location for the proposed device. This must be accomplished by either an on-site visit by the sign owner's representative or by an easily visible stake or marker.

Information will be reviewed and a permit will be issued for signs that comply with all regulations.

If signs do not comply, fees will be returned with a brief explanation concerning the reason for permit refusal.

At the time of application for a permit for a device to be erected, the erector shall arrange with the State Inspector for an inspection of the actual site of the device in accordance with the provisions of the Manual. If the inspector determines that the location and the device proposed to be erected are conforming, a Class A permit will be issued for the erection of the device. After issuance of the permit and notification by the erector, the Inspector will reinspect the erected device and if it complies with all regulations as set out in the Manual a permit marker will be affixed to the device.

If the application for a permit is for an existing device, the Inspector will in like manner inspect the device and site and if the location is determined to be conforming and if the

device complies with all regulations as set out in the Manual, a Class A permit will be issued and a permit marker will be affixed to the device.

If the location of the existing device is determined to be nonconforming or if it does not comply with all regulations set out in the Manual, a Class B permit will be issued and a permit marker will be affixed to the device permitting its existence until it is required by law to be removed.

After 120 days from issuance of permit, the State's Inspector will review the device and if it complies with all regulations, affix a permit decal to the structure. If a device has not been erected within 120 days from the issuance of the permit, the permit will no longer be valid.

Signs without a permit decal are not valid. Permit markers for Class A permits and Class B permits will be of different colors.

Class A permits will expire on December 31 of odd number years (2007, 2009, 2011, etc.). Class B permits will expire on December 31 of even numbered years (2006, 2008, 2010, etc.). Renewal applications must be received by the Arkansas State Highway and Transportation Department, Beautification Section, by December 31 of such years. The renewal fee for a Class A outdoor advertising permit shall be \$20.00. The renewal fee for a Class B permit shall be \$30.00.

By December 1 of such year, a notice of renewal will be sent to the permit-owner.

Commencing December 2006, and each year thereafter, if the renewal application and fee are not received from the permit-owner by December 31, a second renewal notice will be sent to the permit-owner granting until January 31 to renew the permit.

If the renewal application and fee are not received from the permit-owner by January 31, a third renewal notice will be sent by certified mail stating that the permit has expired and a renewal application and fee must be received by the Arkansas State Highway and Transportation Department by the thirtieth day after January 31. Weekends and holidays shall be included when calculating the 30-day period.

If the renewal application and fee are not received from the permit-owner by the thirtieth day after January 31, then the sign must be removed.

It shall be the responsibility of the permit-owner, and not the Arkansas State Highway and Transportation Department, to provide the appropriate mailing address for renewal notification.

SECTION 5.

The following actions and conditions shall be cause for revocation of a permit:

- A. Violation of the laws of the State of Arkansas or these regulations in the erection or maintenance of a device, in the event the sign cannot be maintained in conformity with the law.
- B. Failure to maintain the device in a state of good repair after reasonable notice to the owner that the device is in a state of disrepair.
- C. Fraud or misrepresentation in the application for a permit. The owner of the device will be notified of the pending revocation and given a reasonable time to correct the deficiency. If said deficiency is not then corrected, the device will be removed as an illegal sign.

SECTION 6.

Permits shall not be required for the following signs and devices which are erected in conformance with the regulations hereinafter set out:

- A. Signs or devices in areas with comprehensive zoning.
- B. On premise devices
 - (1) Devices advertising the sale or lease of property on which they are located.
 - (2) Devices advertising activities conducted on the property on which they are located.
 - (a) Property on which advertising activities are conducted means the land occupied by the regularly used building, parking lot, and storage or processing area of a commercial, business, or industrial activity.
- C. Directional and other official signs.
 - (1) Signs erected by or for public officials in the discharge of their duties, such as zoning changes, historical markers, public utility signs, etc.
 - (2) Service Club Signs providing information about meetings of Rotary, Kiwanis or other service clubs, and church signs. These signs must not exceed 8 sq. ft in size.
 - (3) Public service signs on school bus shelters shall not exceed 32 sq. ft. in area and the message shall conform to National Standards for message content.
 - (4) Directional signs.
 - (a) Signs containing directional information about public places owned or operated by Federal, State or local governments or their agencies; public or privately owned natural phenomena, historic, cultural, scientific,

educational and religious sites; and areas of natural scenic beauty or naturally suited for outdoor recreation, deemed to be in the interest of the traveling public.

(b) National Standard Categories for Directional Signs.

(1) General. The following are prohibited: signs advertising illegal activities; signs which are traffic hazards; signs erected on trees or painted on rocks or other natural features; obsolete signs or signs in disrepair; and signs which move.

(2) Size. Shall not exceed 150 sq. ft. in area, 20 feet maximum length, including border and trim but excluding supports.

(3) Lighting. Signs with flashing or moving lights; overly bright or intense lights and lights which would interfere with safe traffic movement are prohibited.

(4) Spacing. Signs shall not be placed within 2000 feet of an interchange, rest area, park lane, or scenic area, or within 1 mile of another directional sign facing the same travel direction; only 3 signs pertaining to the same activity may be erected facing the same direction of travel on a single route approaching the activity; and signs must be within 75 air miles of the activity if the sign is adjacent to an Interstate highway, or 50 air miles if on a primary highway.

(5) Message Content. Must be limited to identification of activity without descriptive words or phrases or pictorial representations.

(6) Selection Criteria. Privately owned attractions or activities must be nationally or regionally known and listed with the Arkansas Historical Society or the Parks and Recreation Commission shall be accepted as evidence of such recognition, but the fact that an attraction or activity is not listed will be conclusive evidence that it is not nationally or regionally known.

Section 7 Electronic Message Devices (EMD)

A. Definitions:

- 1) "*Electronic Message Device (EMD)*" means a sign with the capability of displaying words, symbols, figures or images controlled by electronic communications.
- 2) "*Blinking*" means any form of flashing where a pattern of sudden illumination changes occurs, excluding the transition of electronic messages.
- 3) "*Dissolve*" means a mode of message transition on an Electronic Message Device accomplished by varying the light intensity or pattern, where the first message gradually appears to dissipate and lose legibility simultaneously with the gradual appearance and legibility of the subsequent message.
- 4) "*Fade*" means a mode of message transition on an Electronic Message Device accomplished by varying the light intensity or pattern, where the first message gradually reduces the intensity to the point of not being legible and the subsequent message gradually increases intensity to the point of legibility.
- 5) "*Flashing*" means any pattern of changing light illumination where the sign illumination alternates suddenly between fully illuminated and fully non-illuminated, excluding the transition of electronic messages.
- 6) "*Intermittent*" means any pattern of changing light intensity, other than that achieved with fade, dissolve or instantaneous transitions or the temporary suspension of illumination.
- 7) "*Malfunction*" means any interruption in the normal display on the Electronic Message Device that results in blinking, flashing, intermittent or moving light display of lighting, and any other abnormal function of the sign that would cause distraction to motorists.
- 8) "*Moving light*" means the physical change in position of any visible illumination source while lighted or the simulation of movement achieved with a pattern of sequentially illuminating visible illumination sources within close proximity of each other.

B. All structures that display electronic messages shall be subject to the provisions found in these Regulations, and must be approved by permit prior to installation.

- 1) For permitted structures containing an EMD, only one EMD shall be allowed per facing, and the EMD shall be the only sign allowed on that facing.
- 2) Electronic message changes must be accomplished within an interval of two (2) seconds or less.
- 3) The message or image on an EMD must remain static for a minimum of eight (8) seconds or more.
- 4) EMDs shall contain a default design that will freeze the sign in one position if a malfunction occurs. The Department shall be provided with an on-call contact person and telephone number for every permitted EMD. In the event of malfunction, the contact person must have the ability and authority to make modifications to the displays and lighting levels should the need arise. If modifications cannot be made to correct the malfunction within a timely manner, then the EMD should be disabled until the modifications are made. It shall be the responsibility of the permittee to maintain accurate and current contact information.
- 5) Signs that contain, include, or are illuminated by any flashing, intermittent, or moving light or lights, including animated parts or scrolling messages or images, are prohibited, with the exception of those giving public service information such as time, date, temperature, and weather and/or similar information as approved by the Department.
- 6) There shall be no appearance of a visual dissolve or fading in which any part of one electronic message/display appears simultaneously with any part of a following electronic message/display.
- 7) Should the Department, in its discretion, find the EMD sign, or any display or effect thereon, to cause glare or to impair the vision of the driver of any motor vehicle or which otherwise interferes with the operation of a motor vehicle, the owner of the sign shall, within twenty-four (24) hours after notification by the Department, reduce the intensity of the sign to an acceptable level. Failure to reduce lighting intensity on request may be cause for revocation of the permit.
- 8) A sign owner may modify existing, legal, conforming structures to an EMD only after filing an application and receiving approval by the Department.
- 9) Signs containing EMDs shall not be located closer than 1,500 linear feet along Interstate highways and 1,000 linear feet along non-Interstate state highways of another EMD when viewed from the same direction of the traveled way.
- 10) EMDs shall comply with all other requirements of Federal and State Outdoor Advertising Regulations.
- 11) Failure to adhere to any of these provisions may result in the revocation of the EMD portion of the permit [following due process including notice to comply].

ACT 999 1975

State of Arkansas
Seventieth General Assembly
Regular Session, 1975

AS ENGROSSED 2/26/75

A Bill

HOUSE BILL

665

By: Representative Wilson

For An Act To Be Entitled

1 "AN ACT TO AMEND SECTIONS 3 AND 5 OF ACT 640 OF 1967
2 (ARK. STAT. 76-2504 AND 76-2506) AND TO ADD TO SAID
3 ACT PROVISIONS TO BRING THE STATE OF ARKANSAS WITHIN
4 COMPLIANCE WITH THE FEDERAL-AID HIGHWAY AMENDMENTS OF
5 1974 AND OTHER PROVISIONS."
6

7 WHEREAS, the Congress of the United States has enacted legislation
8 by amending the Highway Beautification Act of 1965 which will cause
9 substantial losses in Federal-Aid Highway Funds apportioned to Arkansas
10 on or after July 1, 1975, unless the Arkansas General Assembly enacts
11 conforming legislation:

12 (a) Regulating the erection and maintenance of outdoor advertising
13 signs, displays and devices which are located more than 660 feet off the
14 nearest edge of the right-of-way of Interstate and Primary or any other
15 state highway designated by the Arkansas State Highway Commission, located
16 outside urban areas, visible from the main traveled way of such highways
17 and erected for the purpose of their message being read from such main
18 traveled way;

19 (b) Providing removal and compensation authority for signs lawfully
20 erected beyond 660 feet which do not conform to the provisions of this
21 Act;

22 NOW, THEREFORE,

23
24 BE IT ENACTED BY THE GENERAL ASSEMBLY OF THE STATE OF ARKANSAS:

25
26 SECTION 1. Notwithstanding any other provision of Section 3 of Act 640
27 of 1967, effective July 1, 1975, signs, displays and devices which are
28 located more than 660 feet from the nearest edge of the right-of-way of
29 Interstate and Primary highways, outside of urban areas, visible from the
30 main traveled way of such highways, and erected with the purpose of their
31 message being read from such main traveled way, shall be limited to:

32 (a) Directional and other official signs as defined herein;

PTP
J. R. Rhee

C. H. Calhoun

1 (b) Signs advertising the sale or lease of property on which they are
2 located;

3 (c) Signs advertising activities conducted on the property on which
4 they are located;

5 (d) signs, displays and devices which locate, identify, mark or
6 warn of the presence of pipelines, utility lines or rail lines and appur-
7 tenances thereto; including, but not limited to, markers used in main-
8 tenance, operation, observation and safety.
9

10 SECTION 2. The Arkansas State Highway Commission is authorized and
11 empowered to require the removal of all outdoor advertising signs, dis-
12 plays and devices which do not conform to the provisions of this Act and
13 which are lawfully erected beyond 660 feet off the nearest edge of the
14 right-of-way, located outside of urban areas, visible from the main travel
15 way of the Interstate, Primary, or any other state highway designated by the
16 Arkansas State Highway Commission, and erected with the purpose of their
17 message being read from such main traveled way, and which right may be en-
18 forced by means of a mandatory injunction or other appropriate remedy, pro-
19 vided, however, that just compensation shall be paid upon the removal of
20 signs, devices and displays that were lawfully erected beyond 660 feet of
21 the right-of-way line of the Interstate, Primary or other State Highways;
22 which compensation shall be paid for the taking from the owner of such sign
23 display or device, and the taking of all right of title, leasehold, and
24 interest in such sign, display or device, and the taking from the owner of
25 the real property on which the sign, display or device is located, of the
26 right to erect and maintain such signs, displays and devices thereon.
27

28 SECTION 3. The General Assembly finds and declares that outdoor
29 advertising signs, displays or devices which are located more than 660 feet
30 off the nearest edge of the right-of-way, located outside of urban areas,
31 visible from the main traveled way of the Interstate, Primary, or other
32 state highway designated by the Arkansas State Highway Commission, and
33 erected for the purpose of their message being read from such main traveled
34 way, and which do not conform to the provisions of this Act are non-
35 conforming advertising devices; therefore, the right is conferred upon
36 the Commission to enforce the provisions of this Act by means of re-

PRESIDENT OF SENATE
Dr. Reeves

1 straining order, mandatory injunction, or other appropriate remedy for
2 the abatement of such non-conforming advertising devices, displays or
3 signs.
4

5 SECTION 4. It is hereby found and declared that the strict enforce-
6 ment of this Act is necessary to prevent the erection of signs, displays
7 and devices beyond the present legal limitations and visible from the
8 traveled right-of-way of the Interstate, Primary and other State Highways;
9 that if this Act is not placed in effect forthwith, the State of Arkansas
10 will lose substantial Federal funds for failure to comply with the Federal-
11 Aid Highway Amendment of 1974; that the immediate enforcement of this Act
12 is required for the public health, safety and welfare. Therefore, it is
13 declared, for these reasons, that an emergency exists and this Act, being
14 essential for the preservation of the public peace, safety and welfare,
15 shall take effect and be in force from and after its passage and approval.
16

17
18 s/ Mike Wilson
19

20
21 APR 11 1975
22 APPROVED BY David Pryor
23 GOVERNOR
24

25
26
27
28
29
30
31
32
33
34
35
36
PRESIDENT OF SENATE

J. R. Reese

B. O. Caldwell